

Prepp

Your Personal Exams Guide



NDA



CDS



SSC CGL



CBSE UGC NET



IAS



SSC CHSL



CTET



MPSC



AFCAT



CSIR UDC NET



IBPS PO



UP POLICE



SSC MTS



SBI PO



BPS



UPTET



IBPS RRB



IBPS CLERK



IES



UPSC CAPF



SSC Stenogr..



RRB NTPC



SSC GD



RBI GRADE B



RBI Assistant



DSSSB

Reasoning: Seating Arrangement Advanced Test

Total Time: 20 Minute

Total Marks: 10

Instructions

1. Test will auto submit when the Time is up.
2. The Test comprises of multiple choice questions (MCQ) with one or more correct answers.
3. The clock in the top right corner will display the remaining time available for you to complete the examination.

Navigating & Answering a Question

1. The answer will be saved automatically upon clicking on an option amongst the given choices of answer.
2. To deselect your chosen answer, click on the clear response button.
3. The marking scheme will be displayed for each question on the top right corner of the test window.

Your Personal Exams Guide

Chapter Test

1. **Direction:** Read the information carefully and answer the questions given below (+1, -0.25)

There is a rectangular table inside the rectangular table there is a hexagonal table. There are eight people M, N, O, P, Q, R, S and T are sitting in a rectangular table. Four are sitting at the corner and four are at the middle of a rectangular table and all are facing towards the center. In hexagon people can sit only on edges, edges denoted by 1, 2, 3, and so on in the anticlockwise direction.

Arrangement in the rectangular table –

N sits second to the right of Q who is immediate of O and S. S does not sit on any of the corners. Only one person sits between O and M. T sits second to the left of M. R is not an immediate neighbor of T.

Now they start playing a card game. One card is drawn by one particular person and he changes his place according to the given conditions.

Conditions –

1. If the card drawn is a square number of spades then the person moves to the hexagon on edge number 6.
2. If the card drawn is a heart then the person moves to the hexagon on edge number 3.
3. If the card drawn is a diamond with a square number then the person moves to the hexagon on edge number 1 else if he picks any other number of diamond, he moves just towards his left.
4. If the card drawn is a club with a prime number then the person moves to the hexagon on edge number 2 else if he picks any other number of the club then he exchanges his seat with the person sitting opposite to him in the rectangular table.

Draws –

1. Q draws 1 of club
2. N draws jack of heart.
3. R draws 9 of spades
4. T draws 8 of diamond
5. S draws 7 of club
6. O draws 4 of diamond

Note - All the persons draw card in a serial same as given above (First Q draws then N draws and so on). Other which are not mentioned in steps is sitting in the rectangular table on the previous position

What is the position of Q after the first draw?

- a. Q is on edge 2 of hexagon
- b. Q is an immediate neighbor of O
- c. Q is immediately right of M
- d. Q is immediate to the right of T
- e. Cannot be determined

2. **Direction:** Read the information carefully and answer the questions given below (+1, -0.25)

There is a rectangular table inside the rectangular table there is a hexagonal table. There are eight people M, N, O, P, Q, R, S and T are sitting in a rectangular table. Four are sitting at the corner and four are at the middle of a rectangular table and all are facing towards the center. In hexagon

people can sit only on edges, edges denoted by 1, 2, 3, and so on in the anticlockwise direction.

Arrangement in the rectangular table –

N sits second to the right of Q who is immediate of O and S. S does not sit on any of the corners. Only one person sits between O and M. T sits second to the left of M. R is not an immediate neighbor of T.

Now they start playing a card game. One card is drawn by one particular person and he changes his place according to the given conditions.

Conditions –

1. If the card drawn is a square number of spades then the person moves to the hexagon on edge number 6.
2. If the card drawn is a heart then the person moves to the hexagon on edge number 3.
3. If the card drawn is a diamond with a square number then the person moves to the hexagon on edge number 1 else if he picks any other number of diamond, he moves just towards his left.
4. If the card drawn is a club with a prime number then the person moves to the hexagon on edge number 2 else if he picks any other number of the club then he exchanges his seat with the person sitting opposite to him in the rectangular table.

Draws –

1. Q draws 1 of club
2. N draws jack of heart.
3. R draws 9 of spades
4. T draws 8 of diamond
5. S draws 7 of club

6. O draws 4 of diamond

Note - All the persons draw card in a serial same as given above (First Q draws then N draws and so on). Other which are not mentioned in steps is sitting in the rectangular table on the previous position

Who among the following sit between P and T when counted in clockwise from T after 4th draw?

- a. N
- b. Other than the given option
- c. S
- d. S, N
- e. No one

3. **Direction:** Read the information carefully and answer the questions given below (+1, -0.25)

There is a rectangular table inside the rectangular table there is a hexagonal table. There are eight people M, N, O, P, Q, R, S and T are sitting in a rectangular table. Four are sitting at the corner and four are at the middle of a rectangular table and all are facing towards the center. In hexagon people can sit only on edges, edges denoted by 1, 2, 3, and so on in the anticlockwise direction.

Arrangement in the rectangular table –

N sits second to the right of Q who is immediate of O and S. S does not sit on any of the corners. Only one person sits between O and M. T sits second to the left of M. R is not an immediate neighbor of T.

Now they start playing a card game. One card is drawn by one particular person and he changes his place according to the given conditions.

Conditions –

1. If the card drawn is a square number of spades then the person moves to the hexagon on edge number 6.
2. If the card drawn is a heart then the person moves to the hexagon on edge number 3.
3. If the card drawn is a diamond with a square number then the person moves to the hexagon on edge number 1 else if he picks any other number of diamond, he moves just towards his left.
4. If the card drawn is a club with a prime number then the person moves to the hexagon on edge number 2 else if he picks any other number of the club then he exchanges his seat with the person sitting opposite to him in the rectangular table.

Draws –

1. Q draws 1 of club
2. N draws jack of heart.
3. R draws 9 of spades
4. T draws 8 of diamond
5. S draws 7 of club
6. O draws 4 of diamond

Note – All the persons draw card in a serial same as given above (First Q draws then N draws and so on). Other which are not mentioned in steps is sitting in the rectangular table on the previous position

What is the position of O after the final draw?

- a. O sits between R and S
- b. O moves to the hexagon on edge number 2

- c. O sits immediate left of P
- d. O sits between Q and T
- e. O sits between R and P

4. **Direction:** Read the information carefully and answer the questions given below (+1, -0.25)

There is a rectangular table inside the rectangular table there is a hexagonal table. There are eight people M, N, O, P, Q, R, S and T are sitting in a rectangular table. Four are sitting at the corner and four are at the middle of a rectangular table and all are facing towards the center. In hexagon people can sit only on edges, edges denoted by 1, 2, 3, and so on in the anticlockwise direction.

Arrangement in the rectangular table –

N sits second to the right of Q who is immediate of O and S. S does not sit on any of the corners. Only one person sits between O and M. T sits second to the left of M. R is not an immediate neighbor of T.

Now they start playing a card game. One card is drawn by one particular person and he changes his place according to the given conditions.

Conditions –

1. If the card drawn is a square number of spades then the person moves to the hexagon on edge number 6.
2. If the card drawn is a heart then the person moves to the hexagon on edge number 3.
3. If the card drawn is a diamond with a square number then the person moves to the hexagon on edge number 1 else if he picks any other number of diamond, he moves just towards his left.

4. If the card drawn is a club with a prime number then the person moves to the hexagon on edge number 2 else if he picks any other number of the club then he exchanges his seat with the person sitting opposite to him in the rectangular table.

Draws –

1. Q draws 1 of club
2. N draws jack of heart.
3. R draws 9 of spades
4. T draws 8 of diamond
5. S draws 7 of club
6. O draws 4 of diamond

Note - All the persons draw card in a serial same as given above (First Q draws then N draws and so on). Other which are not mentioned in steps is sitting in the rectangular table on the previous position

How many persons sit between R and N before starting the game?

- a. None
- b. One
- c. Two
- d. Three
- e. Four

5. **Direction:** Read the information carefully and answer the questions given below (+1, -0.25)

There is a rectangular table inside the rectangular table there is a hexagonal table. There are eight people M, N, O, P, Q, R, S and T are sitting in a rectangular table. Four are sitting at the corner and four are at the middle of a rectangular table and all are facing towards the center. In hexagon people can sit only on edges, edges denoted by 1, 2, 3, and so on in the anticlockwise direction.

Arrangement in the rectangular table –

N sits second to the right of Q who is immediate of O and S. S does not sit on any of the corners. Only one person sits between O and M. T sits second to the left of M. R is not an immediate neighbor of T.

Now they start playing a card game. One card is drawn by one particular person and he changes his place according to the given conditions.

Conditions –

1. If the card drawn is a square number of spades then the person moves to the hexagon on edge number 6.
2. If the card drawn is a heart then the person moves to the hexagon on edge number 3.
3. If the card drawn is a diamond with a square number then the person moves to the hexagon on edge number 1 else if he picks any other number of diamond, he moves just towards his left.
4. If the card drawn is a club with a prime number then the person moves to the hexagon on edge number 2 else if he picks any other number of the club then he exchanges his seat with the person sitting opposite to him in the rectangular table.

Draws –

1. Q draws 1 of club
2. N draws jack of heart.

3. R draws 9 of spades
4. T draws 8 of diamond
5. S draws 7 of club
6. O draws 4 of diamond

Note - All the persons draw card in a serial same as given above (First Q draws then N draws and so on). Other which are not mentioned in steps is sitting in the rectangular table on the previous position

How many persons sit in a rectangular table after the final draw?

- a. Five
- b. One
- c. Three
- d. Four
- e. Two

-
6. **Directions:** Study the following information carefully and answer the questions that follow: (+1, -0.25)

Six people A, B, C, D, E and F are sitting in a circular manner and playing a game of passing a pillow.

This game has the following rules:

1. A song will be played in each round for some duration and at the time of stopping the song the person having the pillow with him will be kicked out.
2. In each round, one person will be kicked out and he has to do some activity. For this activity two persons will sing a song, one will do 50 push-ups, one will play Truth or dare and one will Dance.

3. The first round will start by passing a pillow in a clockwise direction and after this round direction of passing the pillow will be reversed in each round.
4. The kicked out person would give the pillow to the person sitting next to him in the direction of passing a pillow of that round and then the next round will start.
5. In each round, the song will be played for less than 60 seconds.
6. The speed of passing a pillow given is, its average speed of passing for that respective round and in one pass the pillow will be passed from one person to another person.

It is given that for the sitting arrangement two persons are sitting between D and E. A is not an immediate neighbour of D. One person is sitting between F and C. B is an immediate neighbour of C but he is not sitting at the immediate left of C.

At the beginning of **Round - 1**, B had the pillow. Speed of passing the pillow was 6 passes in 4 seconds and the song was being played for 28s.

It is given that D was kicked out in the **Round - 2** and speed of the pillow for this round was 7 passes in 4 seconds. In this round, the song was being played for more duration than that is being played in the first round.

For **Round - 3**, speed of the pillow was 9 passes in 5 seconds and the song was being played for 30 seconds.

For **Round - 4**, speed of the pillow was 7 passes in 3 seconds and the song was being played for 57 seconds.

For the activity, it is given that D had either danced or sung a song. Either person C or E had played Truth or dare. E hadn't sung a song. The persons who had sung a song wasn't kicked out in back to back rounds. The person who kicked out from round-3 hadn't danced. Also, the person who kicked out in a round in which the duration of the song played is multiple of 3 hadn't danced.

What is the length of the song (in seconds) played in the second round?

- a. 48
- b. 46
- c. 32
- d. 36
- e. 40

7. **Directions:** Study the following information carefully and answer the questions that follow: (+1, -0.25)

Six people A, B, C, D, E and F are sitting in a circular manner and playing a game of passing a pillow.

This game has the following rules:

1. A song will be played in each round for some duration and at the time of stopping the song the person having the pillow with him will be kicked out.
2. In each round, one person will be kicked out and he has to do some activity. For this activity two persons will sing a song, one will do 50 push-ups, one will play Truth or dare and one will Dance.
3. The first round will start by passing a pillow in a clockwise direction and after this round direction of passing the pillow will be reversed in each round.
4. The kicked out person would give the pillow to the person sitting next to him in the direction of passing a pillow of that round and then the next round will start.
5. In each round, the song will be played for less than 60 seconds.

6. The speed of passing a pillow given is, its average speed of passing for that respective round and in one pass the pillow will be passed from one person to another person.

It is given that for the sitting arrangement two persons are sitting between D and E. A is not an immediate neighbour of D. One person is sitting between F and C. B is an immediate neighbour of C but he is not sitting at the immediate left of C.

At the beginning of **Round - 1**, B had the pillow. Speed of passing the pillow was 6 passes in 4 seconds and the song was being played for 28s.

It is given that D was kicked out in the **Round - 2** and speed of the pillow for this round was 7 passes in 4 seconds. In this round, the song was being played for more duration than that is being played in the first round.

For **Round - 3**, speed of the pillow was 9 passes in 5 seconds and the song was being played for 30 seconds.

For **Round - 4**, speed of the pillow was 7 passes in 3 seconds and the song was being played for 57 seconds.

For the activity, it is given that D had either danced or sung a song. Either person C or E had played Truth or dare. E hadn't sung a song. The persons who had sung a song wasn't kicked out in back to back rounds. The person who kicked out from round-3 hadn't danced. Also, the person who kicked out in a round in which the duration of the song played is multiple of 3 hadn't danced.

Who among these had danced?

- a. B
- b. F
- c. C
- d. Can't be determined

e. G

8. **Directions:** Study the following information carefully and answer the questions that follow:

(+1, -0.25)

Six people A, B, C, D, E and F are sitting in a circular manner and playing a game of passing a pillow.

This game has the following rules:

1. A song will be played in each round for some duration and at the time of stopping the song the person having the pillow with him will be kicked out.

2. In each round, one person will be kicked out and he has to do some activity. For this activity two persons will sing a song, one will do 50 push-ups, one will play Truth or dare and one will Dance.

3. The first round will start by passing a pillow in a clockwise direction and after this round direction of passing the pillow will be reversed in each round.

4. The kicked out person would give the pillow to the person sitting next to him in the direction of passing a pillow of that round and then the next round will start.

5. In each round, the song will be played for less than 60 seconds.

6. The speed of passing a pillow given is, its average speed of passing for that respective round and in one pass the pillow will be passed from one person to another person.

It is given that for the sitting arrangement two persons are sitting between D and E. A is not an immediate neighbour of D. One person is sitting between F and C. B is an immediate neighbour of C but he is not sitting at the immediate left of C.

At the beginning of **Round - 1**, B had the pillow. Speed of passing the pillow was 6 passes in 4 seconds and the song was being played for 28s.

It is given that D was kicked out in the **Round - 2** and speed of the pillow for this round was 7 passes in 4 seconds. In this round, the song was being played for more duration than that is being played in the first round.

For **Round - 3**, speed of the pillow was 9 passes in 5 seconds and the song was being played for 30 seconds.

For **Round - 4**, speed of the pillow was 7 passes in 3 seconds and the song was being played for 57 seconds.

For the activity, it is given that D had either danced or sung a song. Either person C or E had played Truth or dare. E hadn't sung a song. The persons who had sung a song wasn't kicked out in back to back rounds. The person who kicked out from round-3 hadn't danced. Also, the person who kicked out in a round in which the duration of the song played is multiple of 3 hadn't danced.

Who was the winner?

- a. C or E
- b. B
- c. A or C
- d. E
- e. C

9. **Directions:** Study the following information carefully and answer the questions that follow:

(+1, -0.25)

Six people A, B, C, D, E and F are sitting in a circular manner and playing a game of passing a pillow.

This game has the following rules:

1. A song will be played in each round for some duration and at the time of stopping the song the person having the pillow with him will be kicked out.
2. In each round, one person will be kicked out and he has to do some activity. For this activity two persons will sing a song, one will do 50 push-ups, one will play Truth or dare and one will Dance.
3. The first round will start by passing a pillow in a clockwise direction and after this round direction of passing the pillow will be reversed in each round.
4. The kicked out person would give the pillow to the person sitting next to him in the direction of passing a pillow of that round and then the next round will start.
5. In each round, the song will be played for less than 60 seconds.
6. The speed of passing a pillow given is, its average speed of passing for that respective round and in one pass the pillow will be passed from one person to another person.

It is given that for the sitting arrangement two persons are sitting between D and E. A is not an immediate neighbour of D. One person is sitting between F and C. B is an immediate neighbour of C but he is not sitting at the immediate left of C.

At the beginning of **Round - 1**, B had the pillow. Speed of passing the pillow was 6 passes in 4 seconds and the song was being played for 28s.

It is given that D was kicked out in the **Round - 2** and speed of the pillow for this round was 7 passes in 4 seconds. In this round, the song was being played for more duration than that is being played in the first round.

For **Round - 3**, speed of the pillow was 9 passes in 5 seconds and the song was being played for 30 seconds.

For **Round - 4**, speed of the pillow was 7 passes in 3 seconds and the song was being played for 57 seconds.

For the activity, it is given that D had either danced or sung a song. Either person C or E had played Truth or dare. E hadn't sung a song. The persons who had sung a song wasn't kicked out in back to back rounds. The person who kicked out from round-3 hadn't danced. Also, the person who kicked out in a round in which the duration of the song played is multiple of 3 hadn't danced.

F has performed which activity?

- a. Can't be determined
- b. Playing Truth or dare
- c. Dancing
- d. Doing 50 push ups
- e. Singing a song

10. **Directions:** Study the following information carefully and answer the questions that follow:

(+1, -0.25)

Six people A, B, C, D, E and F are sitting in a circular manner and playing a game of passing a pillow.

This game has the following rules:

1. A song will be played in each round for some duration and at the time of stopping the song the person having the pillow with him will be kicked out.
2. In each round, one person will be kicked out and he has to do some activity. For this activity two persons will sing a song, one will do 50 push-ups, one will play Truth or dare and one will Dance.
3. The first round will start by passing a pillow in a clockwise direction and after this round direction of passing the pillow will be reversed in each round.

4. The kicked out person would give the pillow to the person sitting next to him in the direction of passing a pillow of that round and then the next round will start.

5. In each round, the song will be played for less than 60 seconds.

6. The speed of passing a pillow given is, its average speed of passing for that respective round and in one pass the pillow will be passed from one person to another person.

It is given that for the sitting arrangement two persons are sitting between D and E. A is not an immediate neighbour of D. One person is sitting between F and C. B is an immediate neighbour of C but he is not sitting at the immediate left of C.

At the beginning of **Round - 1**, B had the pillow. Speed of passing the pillow was 6 passes in 4 seconds and the song was being played for 28s.

It is given that D was kicked out in the **Round - 2** and speed of the pillow for this round was 7 passes in 4 seconds. In this round, the song was being played for more duration than that is being played in the first round.

For **Round - 3**, speed of the pillow was 9 passes in 5 seconds and the song was being played for 30 seconds.

For **Round - 4**, speed of the pillow was 7 passes in 3 seconds and the song was being played for 57 seconds.

For the activity, it is given that D had either danced or sung a song. Either person C or E had played Truth or dare. E hadn't sung a song. The persons who had sung a song wasn't kicked out in back to back rounds. The person who kicked out from round-3 hadn't danced. Also, the person who kicked out in a round in which the duration of the song played is multiple of 3 hadn't danced.

A was kicked out during which round?

a. Round-2

- b.** Round-3
- c.** Round-1
- d.** Round-4
- e.** E wasn't kicked out

prepp

Your Personal Exams Guide

Answers

1. Answer: d

Explanation:

- 1) N sits second to the right of Q who is immediate of O and S.
- 2) S does not sit on any of the corners.
- 3) Only one person sits between O and M.

Case 1:

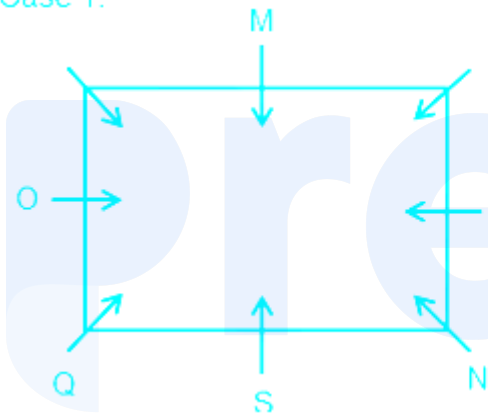

Case 2:

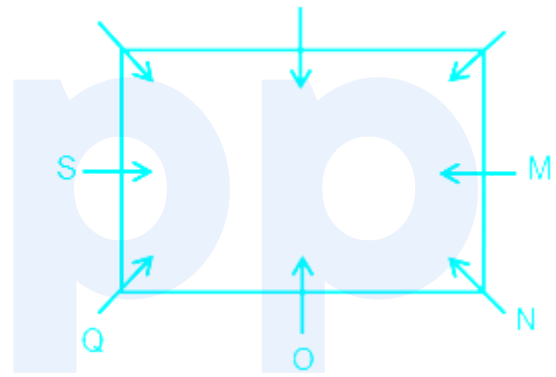

- 4) T sits second to the left of M. (This eliminates case 2)
- 5) R is not an immediate neighbor of T.

Case 1:

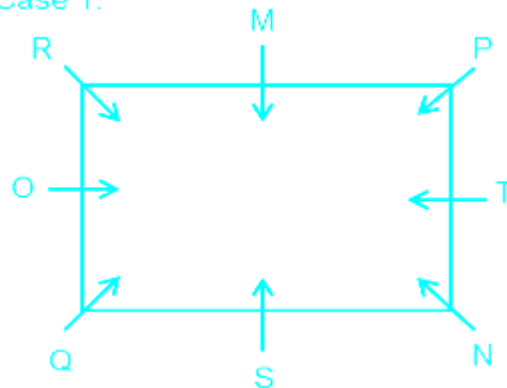

- 6) There is a rectangular table inside the rectangular table there is a hexagonal table.

Draws –

1) Q draws 1 of the club (Apply condition 4 on this. 1 is not a prime number so Q exchange his seat with P)

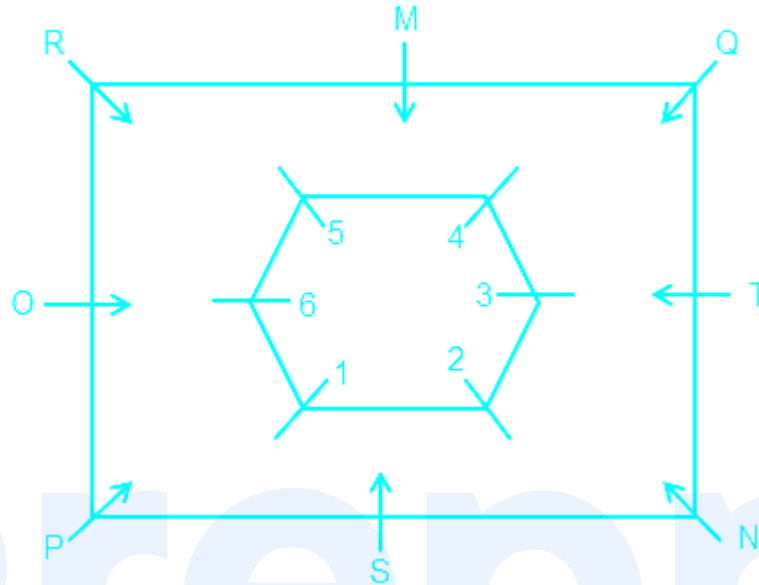

2) N draws jack of heart. (Apply condition 2, N moves to the hexagon on edge number 3.)

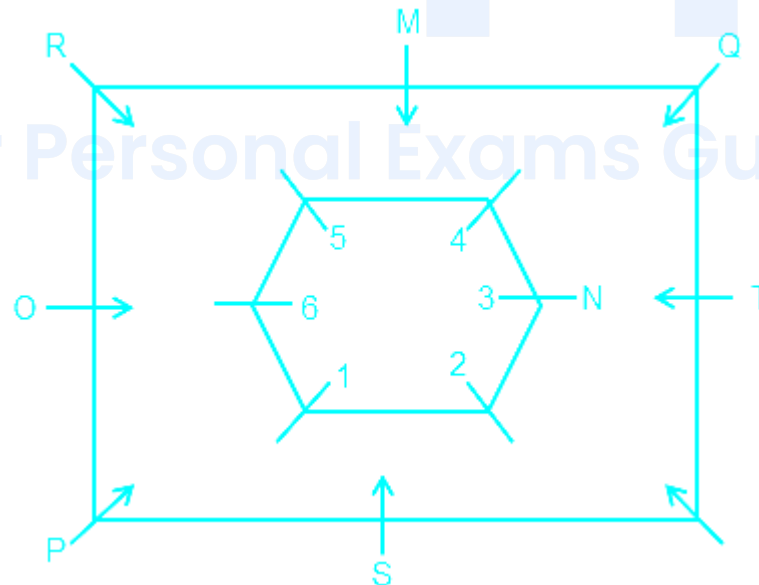

3) R draws 9 of spades. (Apply condition 1, R moves to the hexagon on edge number 6.)

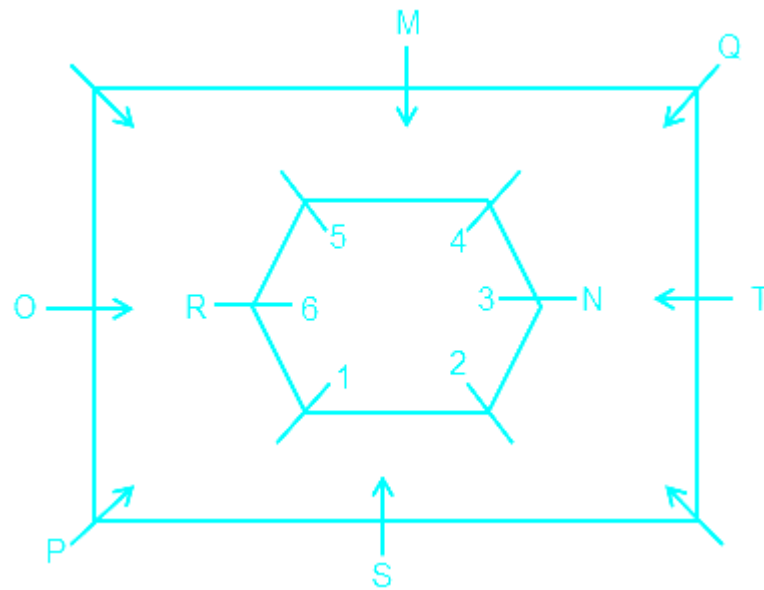

4) T draws 8 of the diamond (Apply condition 3, 8 is not a square number so T moves just towards his left.)

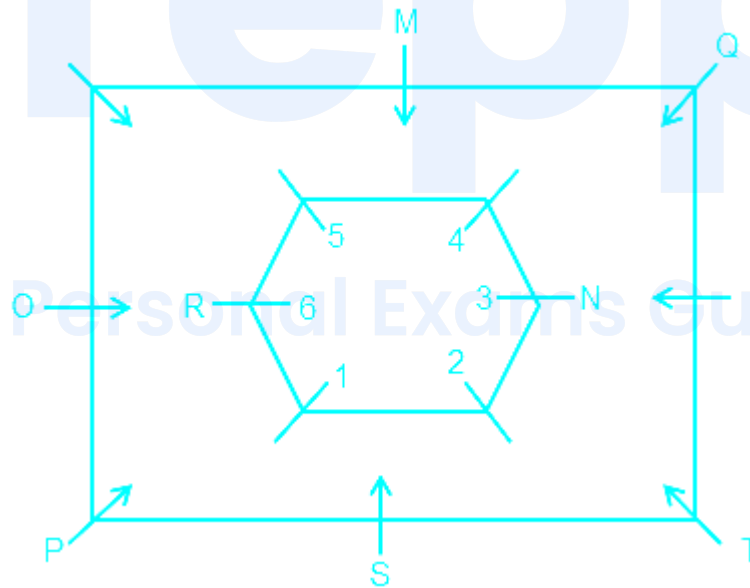

5) S draws 7 of the club. (Apply condition 4, 7 is a prime number so S moves to the hexagon on edge number 2)

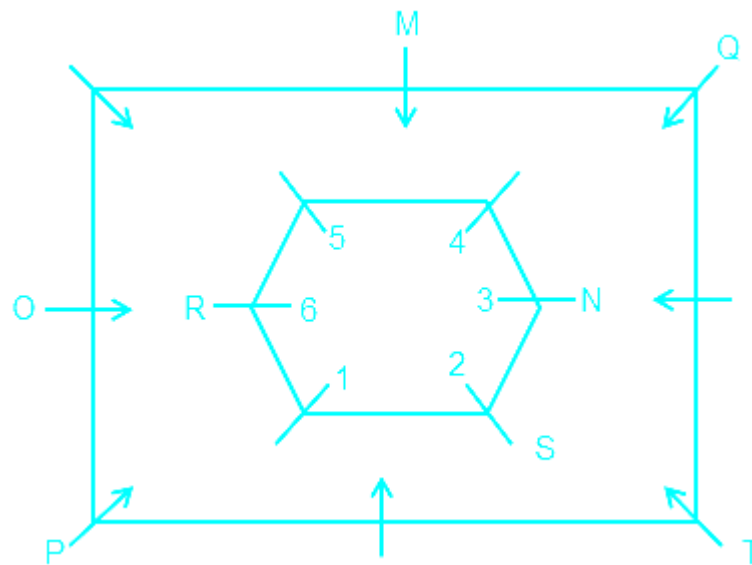

6) O draws 4 of the diamond (Apply condition 3, 4 is a square number so moves to the hexagon on edge number 1)

7) Other which are not mentioned in steps is sitting in the rectangular table on the previous position

Final sitting after all draws

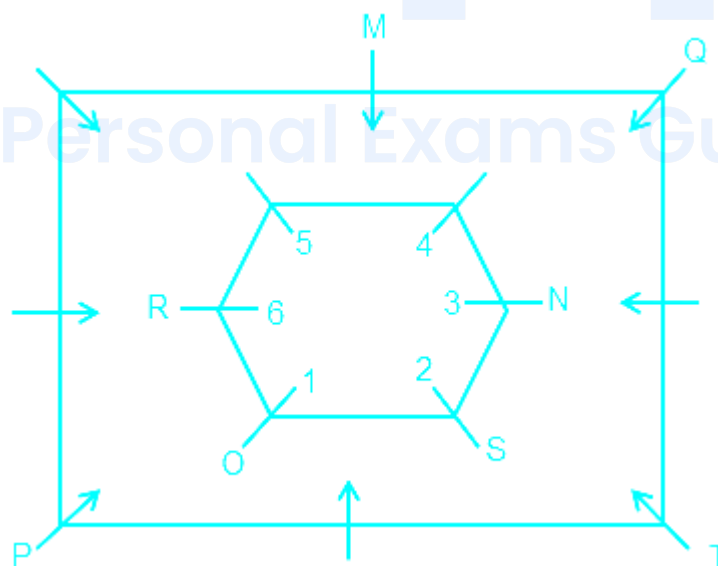

Hence, after 1st draw Q sits immediately to the right of T.

2. Answer: c

Explanation:

- 1) N sits second to the right of Q who is immediate of O and S.
- 2) S does not sit on any of the corners.
- 3) Only one person sits between O and M.

Case 1:

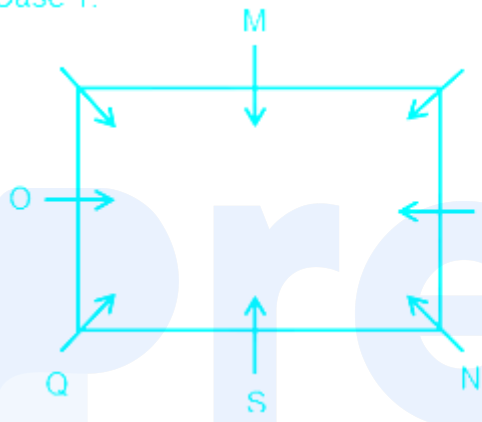

Case 2:

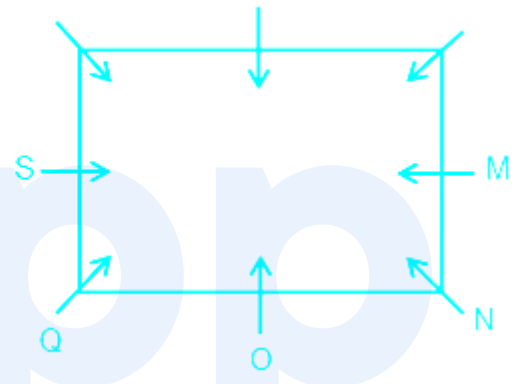

- 4) T sits second to the left of M. (This eliminates case 2)
- 5) R is not an immediate neighbor of T.

Your Personal Exams Guide

Case 1:

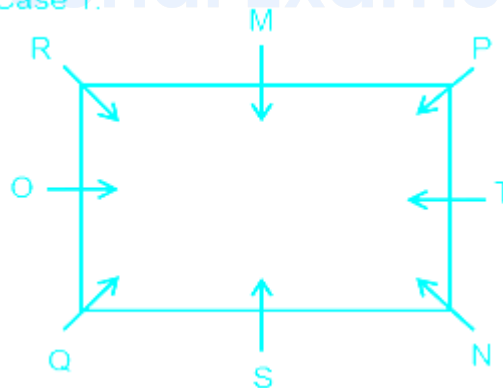

- 6) There is a rectangular table inside the rectangular table there is a hexagonal table.

Draws –

1) Q draws 1 of the club (Apply condition 4 on this. 1 is not a prime number so Q exchange his seat with P)

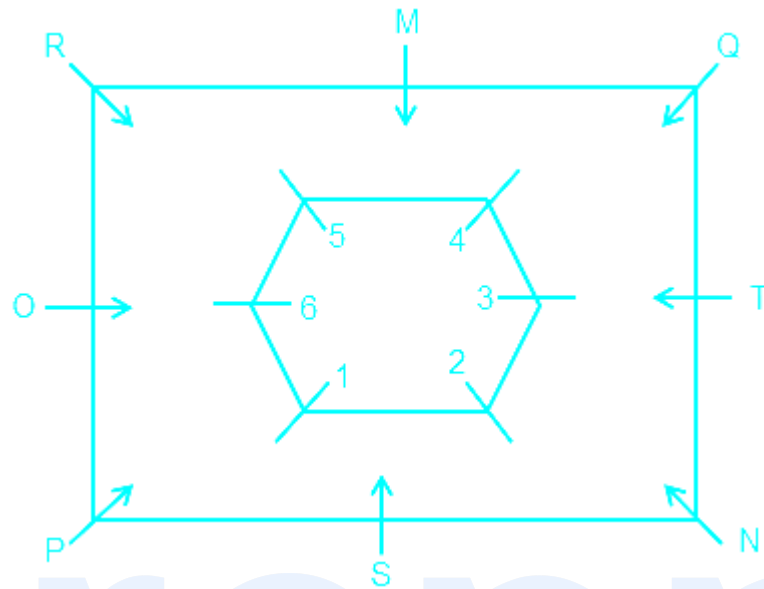

2) N draws jack of heart. (Apply condition 2, N moves to the hexagon on edge number 3.)

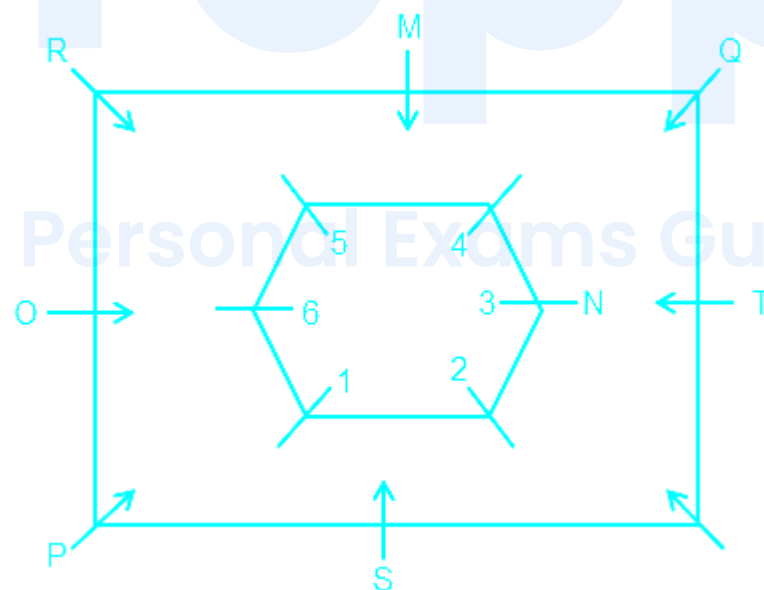

3) R draws 9 of spades. (Apply condition 1, R moves to the hexagon on edge number 6.)

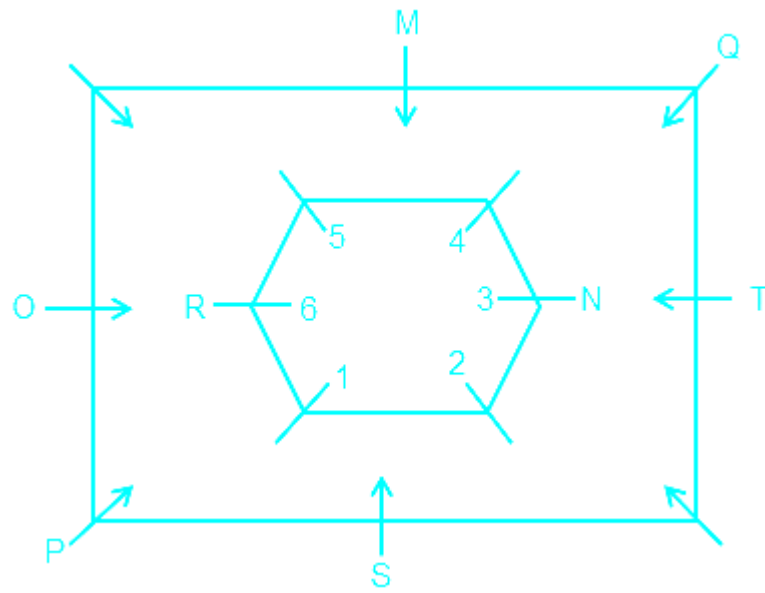

4) T draws 8 of the diamond (Apply condition 3, 8 is not a square number so T moves just towards his left.)

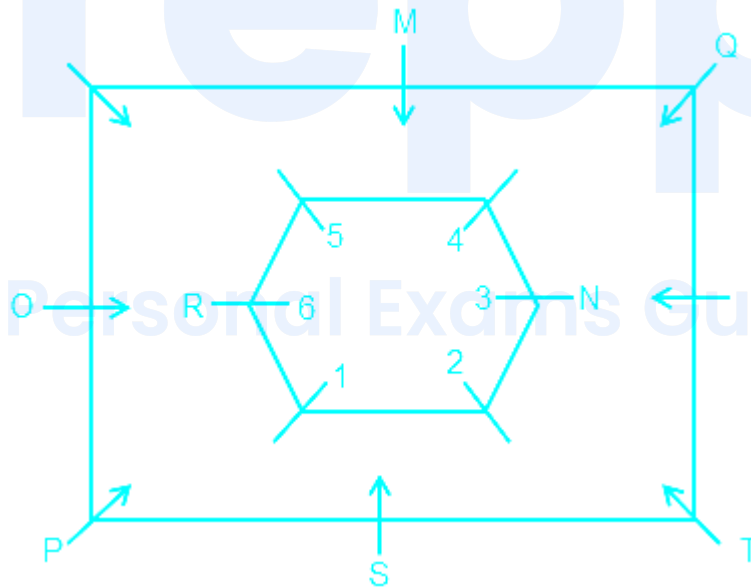

5) S draws 7 of the club. (Apply condition 4, 7 is a prime number so S moves to the hexagon on edge number 2)

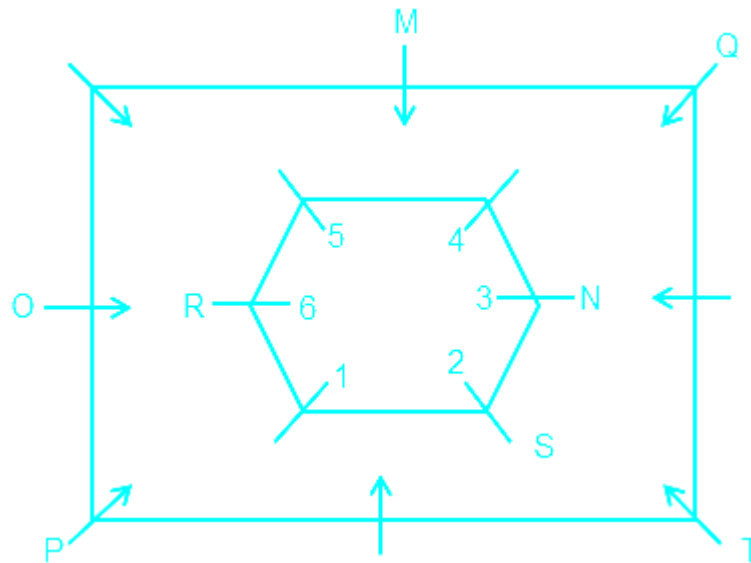

6) O draws 4 of the diamond (Apply condition 3, 4 is a square number so moves to the hexagon on edge number 1)

7) Other which are not mentioned in steps is sitting in the rectangular table on the previous position

Final sitting after all draws

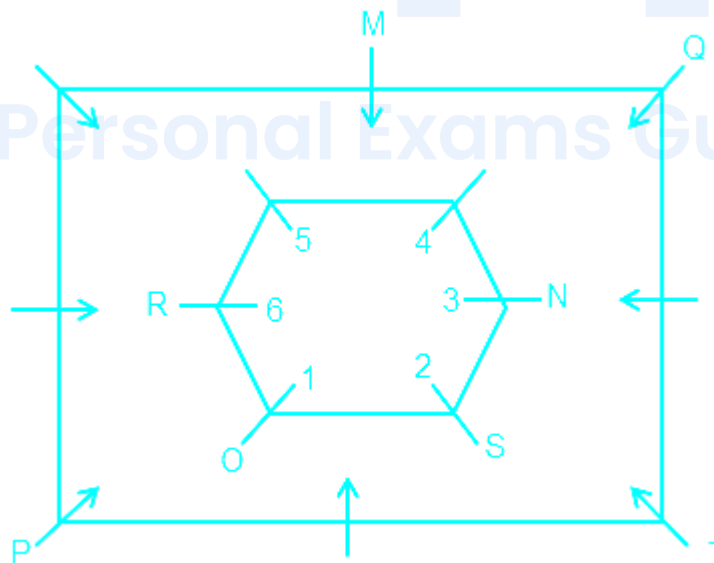

Hence, S sits between P and T when counted in clockwise from T after 4th draw.

3. Answer: a

Explanation:

- 1) N sits second to the right of Q who is immediate of O and S.
- 2) S does not sit on any of the corners.
- 3) Only one person sits between O and M.

Case 1:

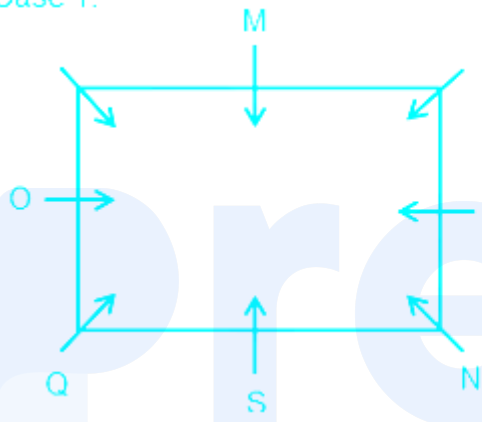

Case 2:

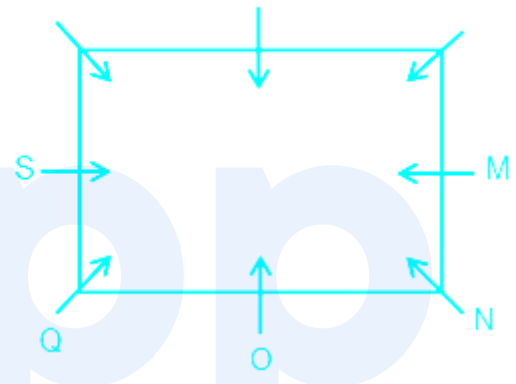

- 4) T sits second to the left of M. (This eliminates case 2)
- 5) R is not an immediate neighbor of T.

Your Personal Exams Guide

Case 1:

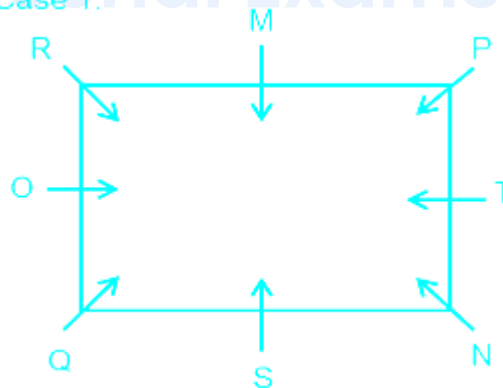

- 6) There is a rectangular table inside the rectangular table there is a hexagonal table.

Draws –

1) Q draws 1 of the club (Apply condition 4 on this. 1 is not a prime number so Q exchange his seat with P)

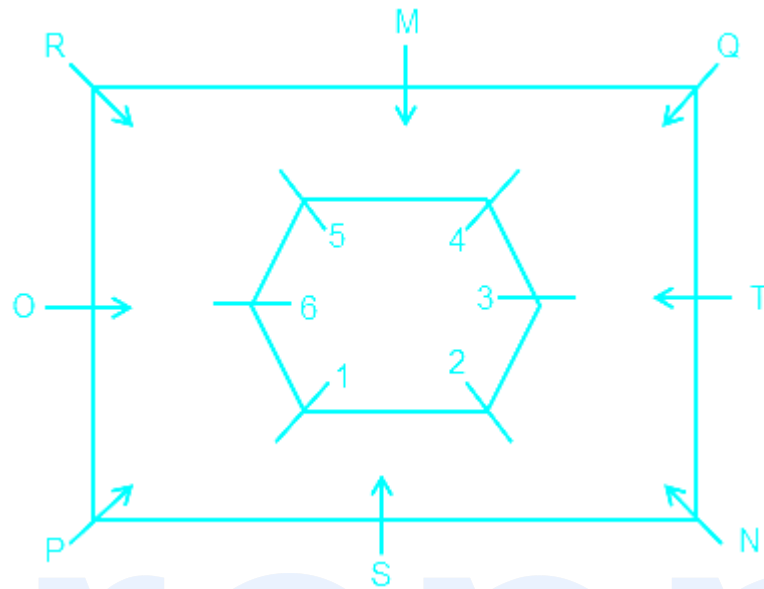

2) N draws jack of heart. (Apply condition 2, N moves to the hexagon on edge number 3.)

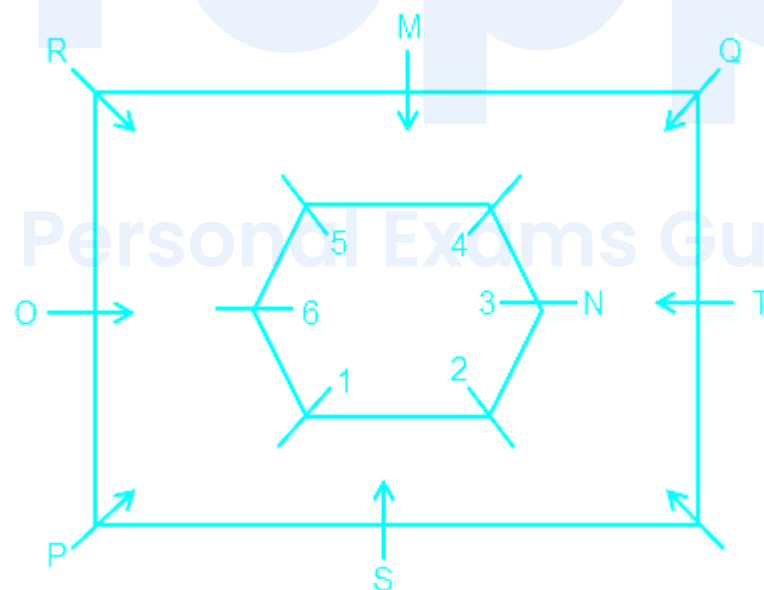

3) R draws 9 of spades. (Apply condition 1, R moves to the hexagon on edge number 6.)

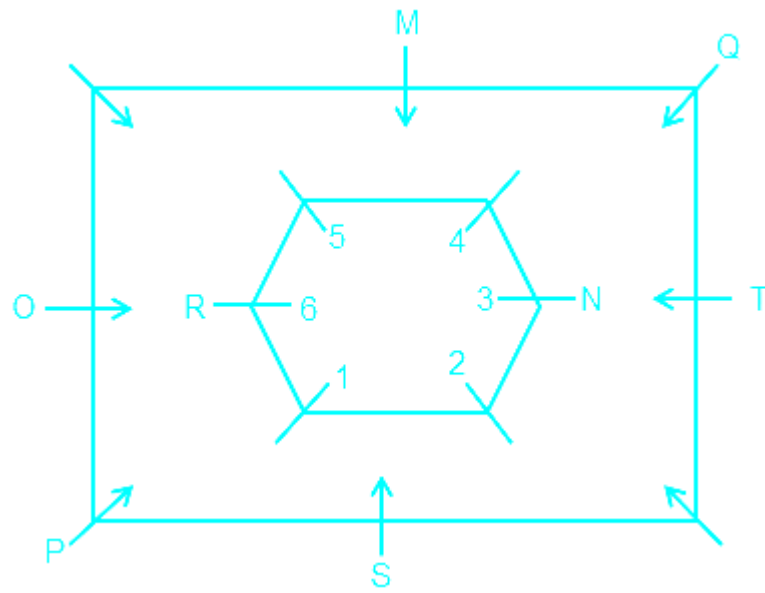

4) T draws 8 of the diamond (Apply condition 3, 8 is not a square number so T moves just towards his left.)

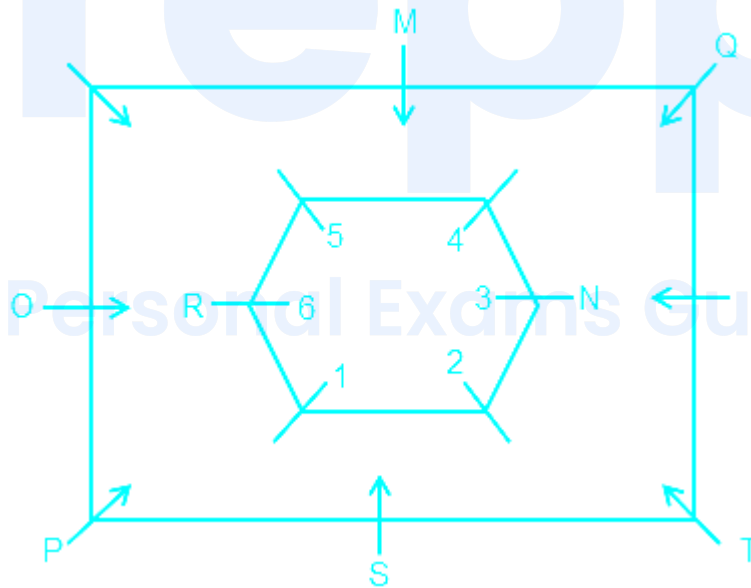

5) S draws 7 of the club. (Apply condition 4, 7 is a prime number so S moves to the hexagon on edge number 2)

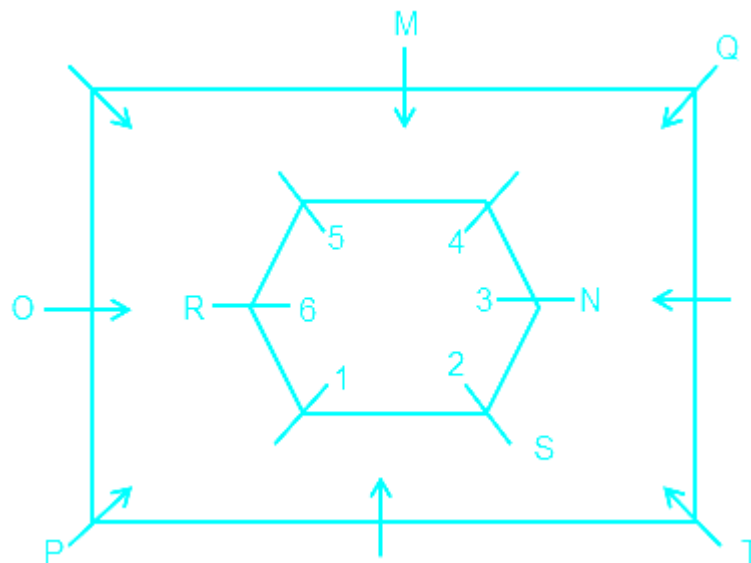

6) O draws 4 of the diamond (Apply condition 3, 4 is a square number so moves to the hexagon on edge number 1)

7) Other which are not mentioned in steps is sitting in the rectangular table on the previous position

Final sitting after all draws

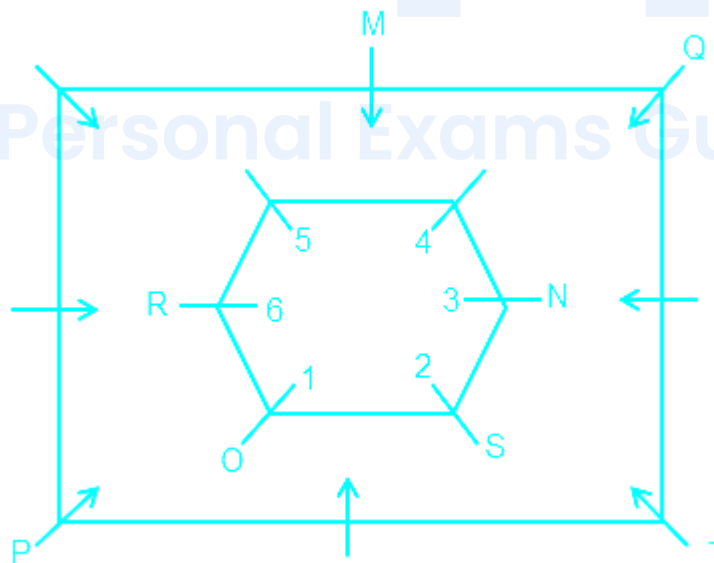

Hence, O sits between R and S after the final draw.

4. Answer: d

Explanation:

- 1) N sits second to the right of Q who is immediate of O and S.
- 2) S does not sit on any of the corners.
- 3) Only one person sits between O and M.

Case 1:

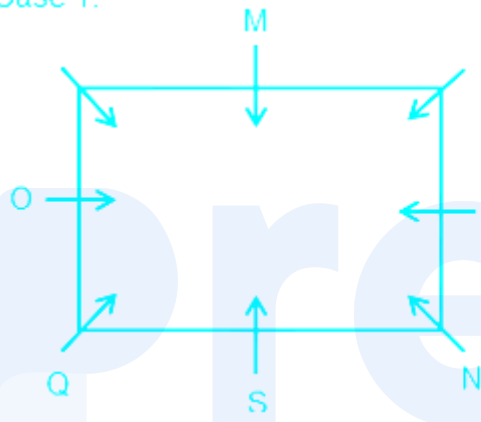

Case 2:

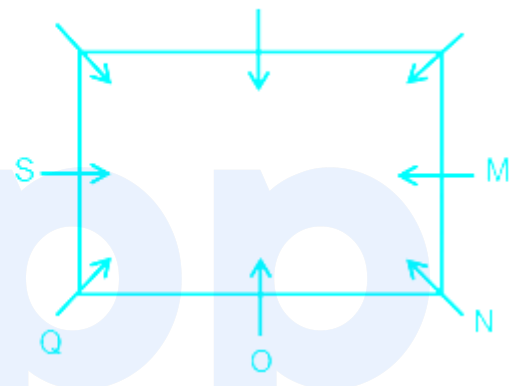

- 4) T sits second to the left of M. (This eliminates case 2)
- 5) R is not an immediate neighbor of T.

Your Personal Exams Guide

Case 1:

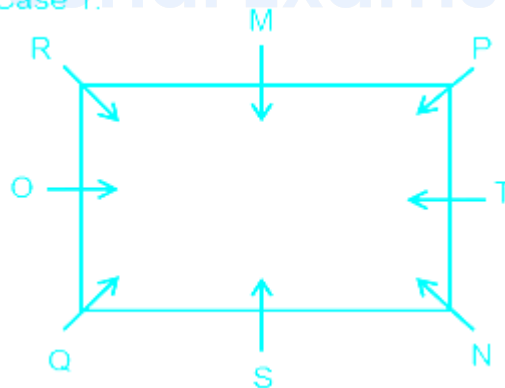

- 6) There is a rectangular table inside the rectangular table there is a hexagonal table.

Draws –

1) Q draws 1 of the club (Apply condition 4 on this. 1 is not a prime number so Q exchange his seat with P)

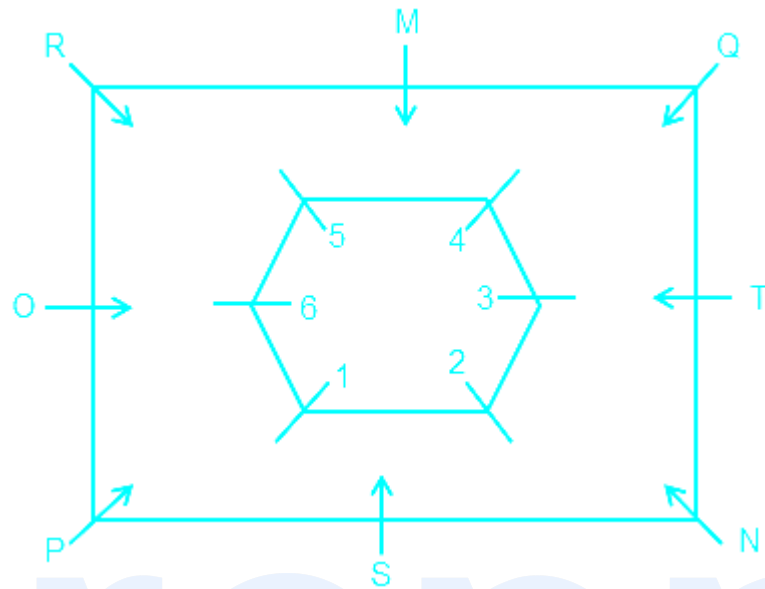

2) N draws jack of heart. (Apply condition 2, N moves to the hexagon on edge number 3.)

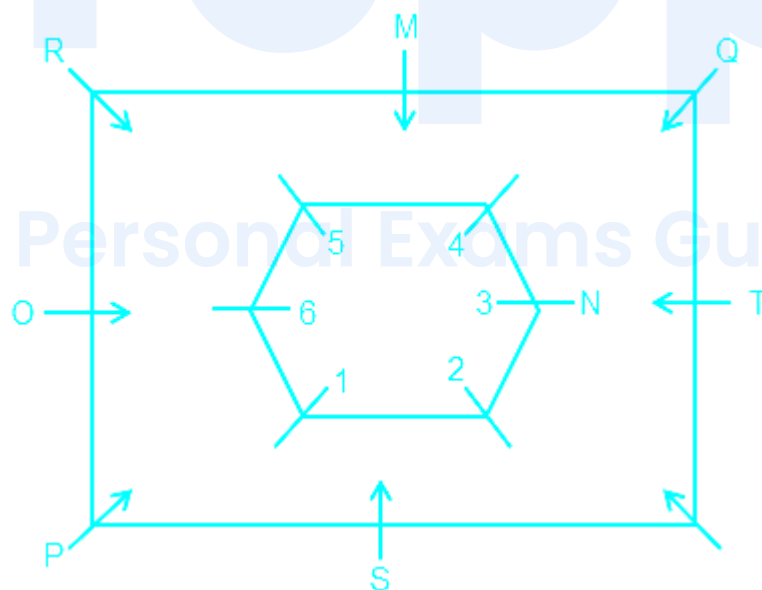

3) R draws 9 of spades. (Apply condition 1, R moves to the hexagon on edge number 6.)

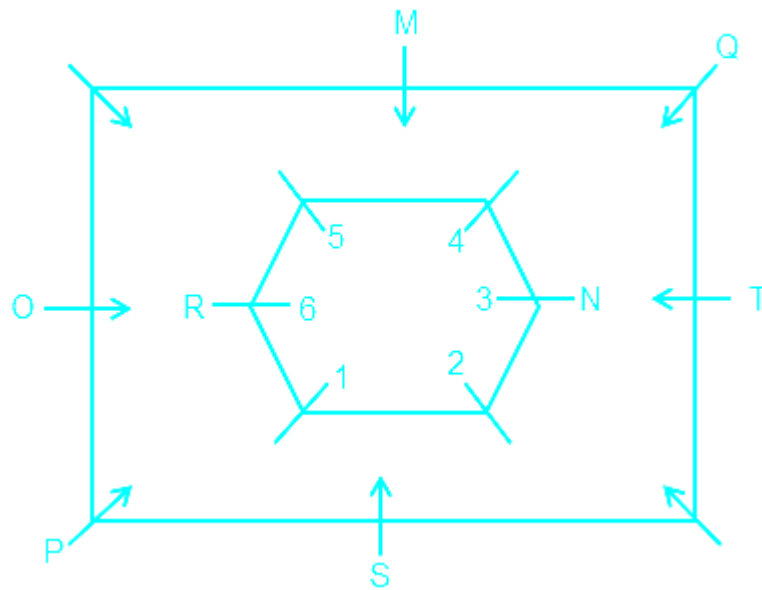

4) T draws 8 of the diamond (Apply condition 3, 8 is not a square number so T moves just towards his left.)

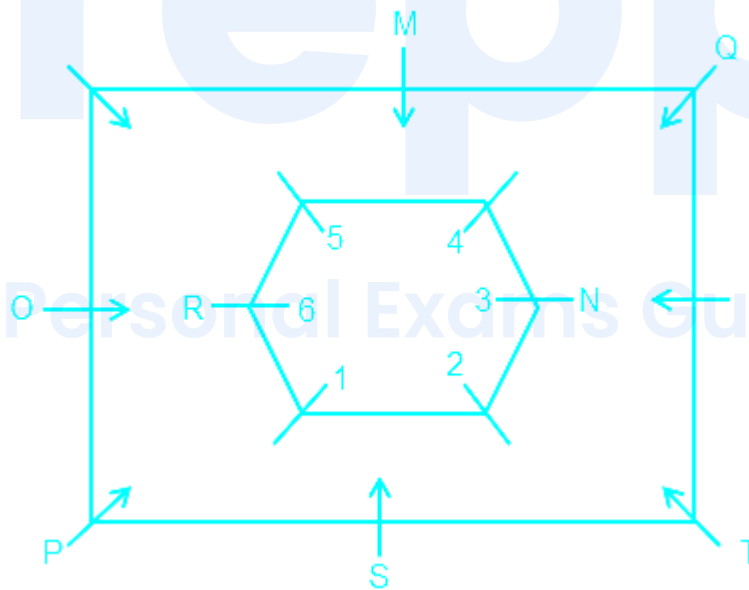

5) S draws 7 of the club. (Apply condition 4, 7 is a prime number so S moves to the hexagon on edge number 2)

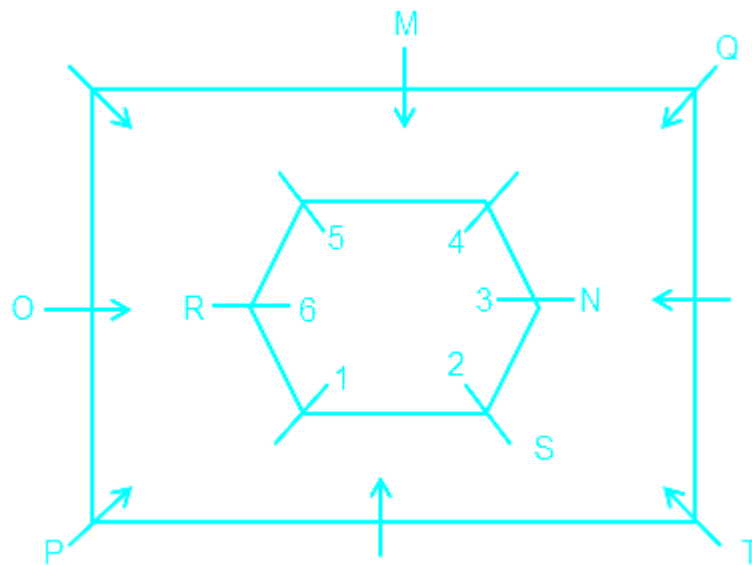

6) O draws 4 of the diamond (Apply condition 3, 4 is a square number so moves to the hexagon on edge number 1)

7) Other which are not mentioned in steps is sitting in the rectangular table on the previous position

Final sitting after all draws

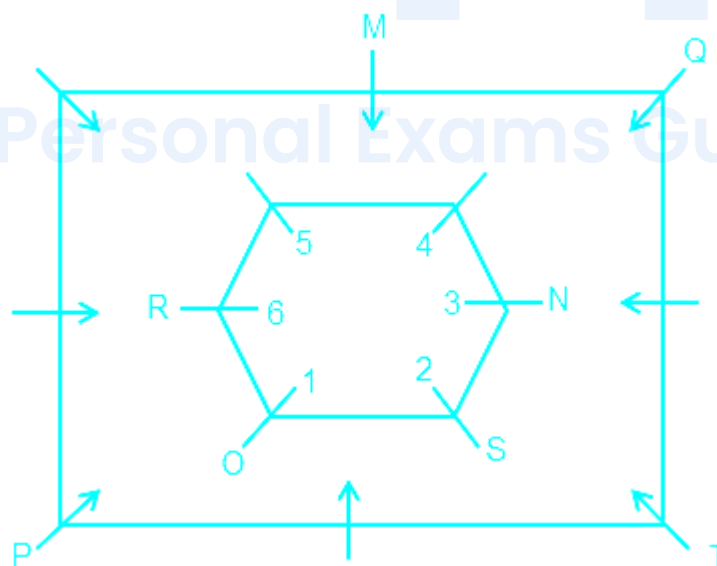

Hence, three persons sit between R and N before starting the game.

5. Answer: d

Explanation:

- 1) N sits second to the right of Q who is immediate of O and S.
- 2) S does not sit on any of the corners.
- 3) Only one person sits between O and M.

Case 1:

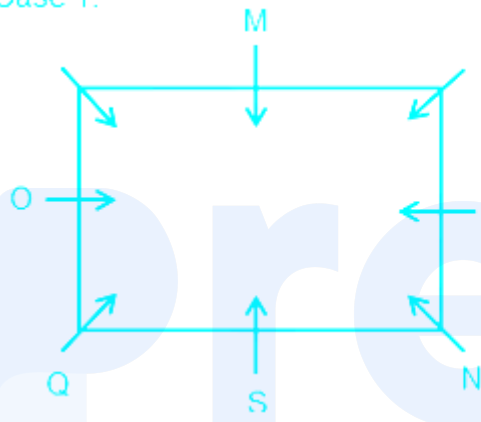

Case 2:

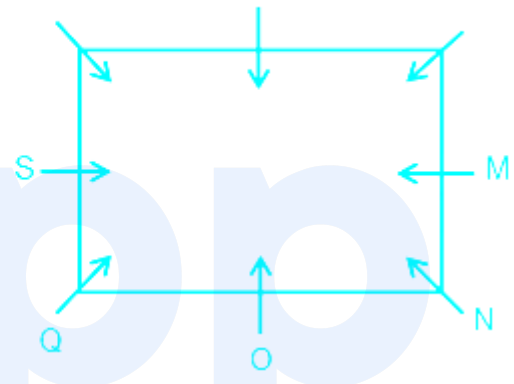

- 4) T sits second to the left of M. (This eliminates case 2)
- 5) R is not an immediate neighbor of T.

Your Personal Exams Guide

Case 1:

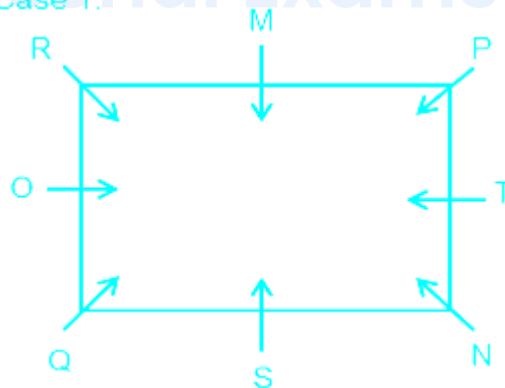

- 6) There is a rectangular table inside the rectangular table there is a hexagonal table.

Draws –

1) Q draws 1 of the club (Apply condition 4 on this. 1 is not a prime number so Q exchange his seat with P)

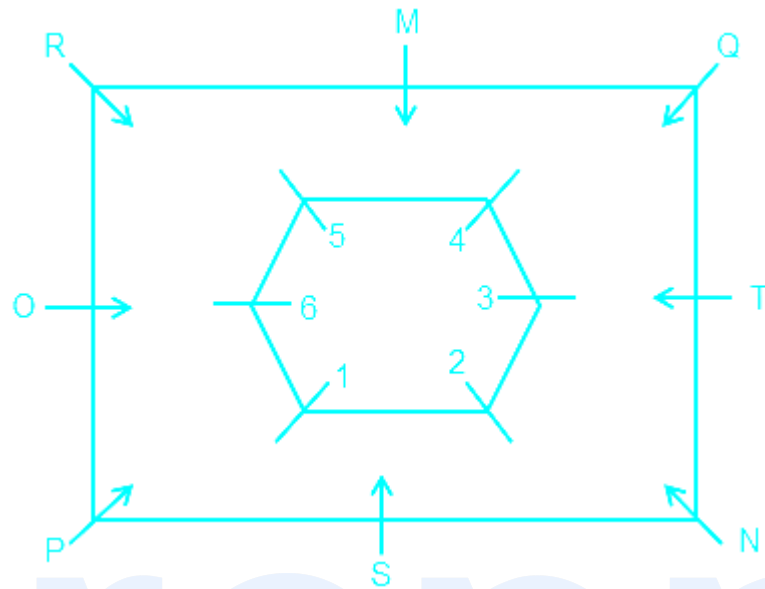

2) N draws jack of heart. (Apply condition 2, N moves to the hexagon on edge number 3.)

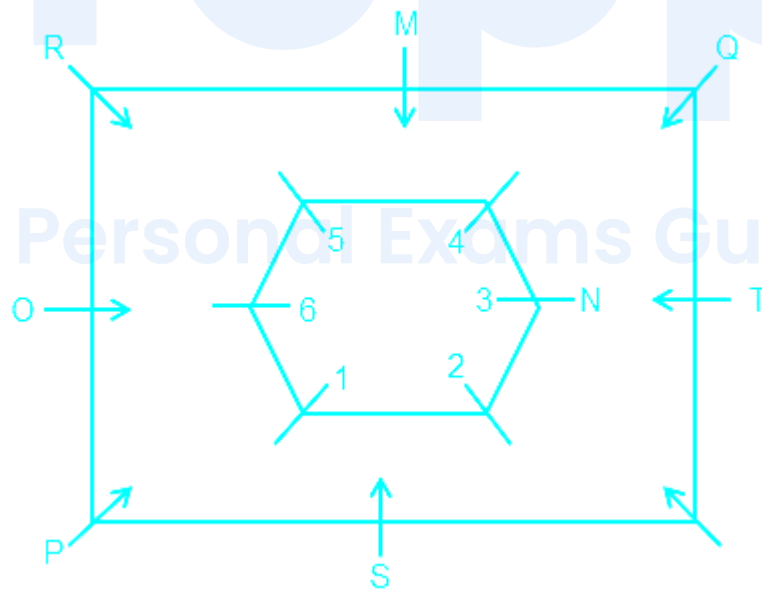

3) R draws 9 of spades. (Apply condition 1, R moves to the hexagon on edge number 6.)

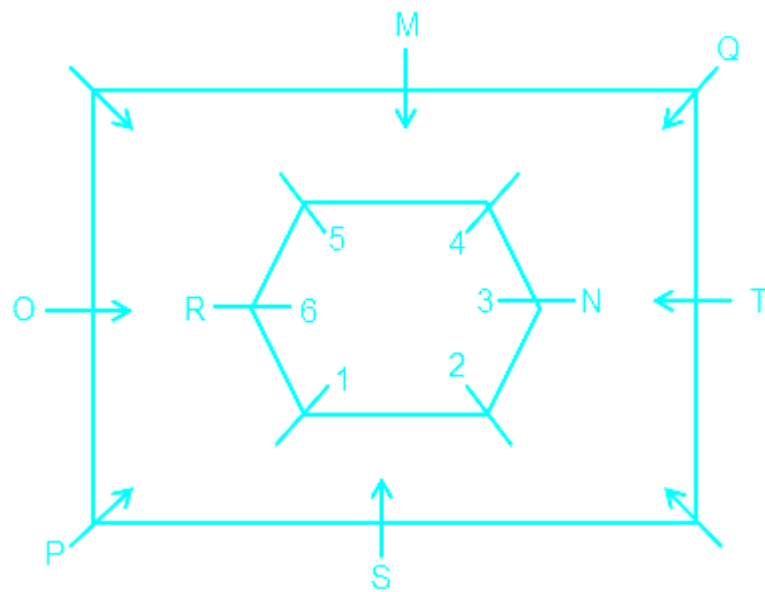

4) T draws 8 of the diamond (Apply condition 3, 8 is not a square number so T moves just towards his left.)

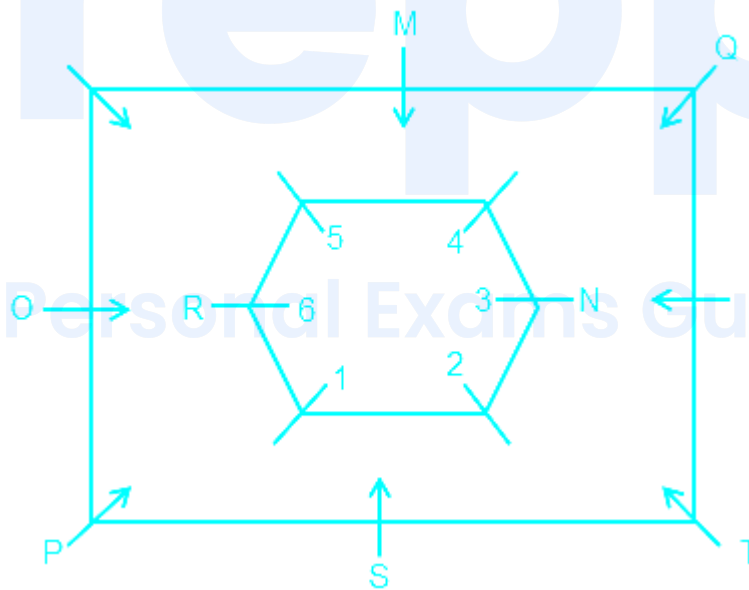

5) S draws 7 of the club. (Apply condition 4, 7 is a prime number so S moves to the hexagon on edge number 2)

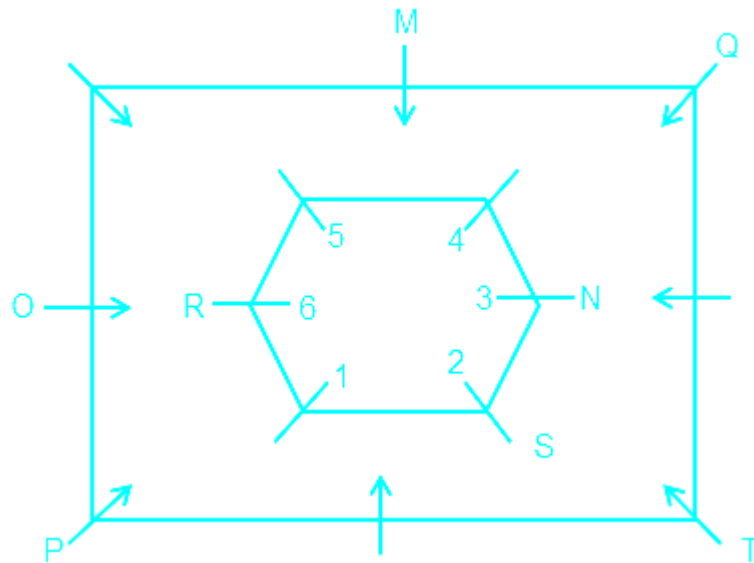

6) O draws 4 of the diamond (Apply condition 3, 4 is a square number so moves to the hexagon on edge number 1)

7) Other which are not mentioned in steps is sitting in the rectangular table on the previous position

Final sitting after all draws

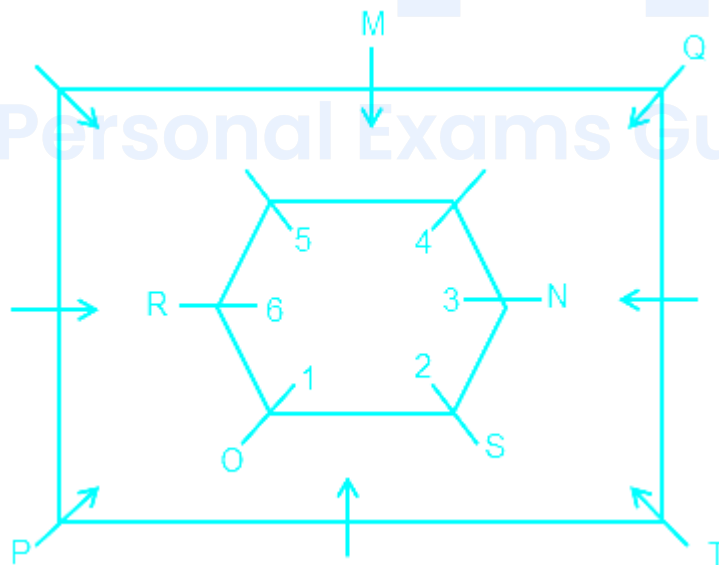

Hence, four persons sit in a rectangular table after the final draw.

6. Answer: a

Explanation:

The seating arrangement of six peoples:

i) Two persons are sitting between D and E.

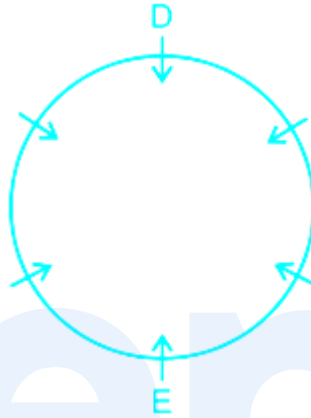

ii) A is not an immediate neighbour of D.

From the above statement, we have two cases i.e. Case-1 & Case-2;

Case-1

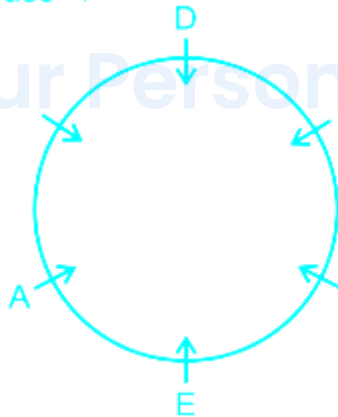

Case-2

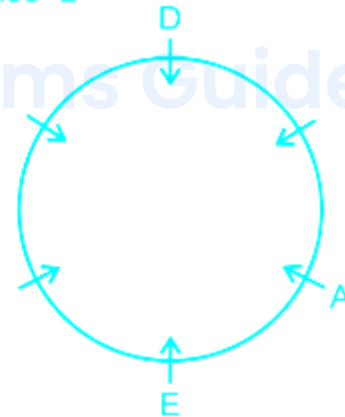

iii) One person is sitting between F and C. B is an immediate neighbour of C.

Case- 1

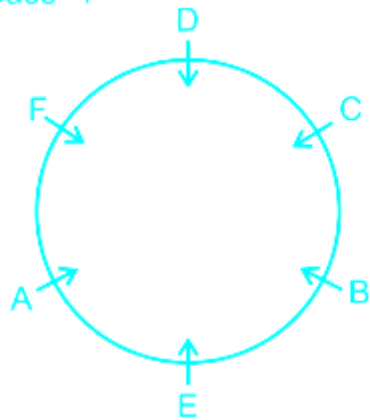

Case- 2

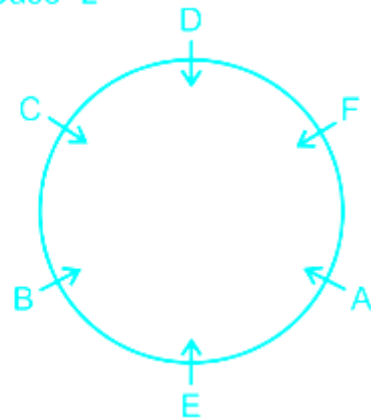

iv) B is not sitting at the immediate left of C. So, Case-1 gets eliminated.

Case- 2

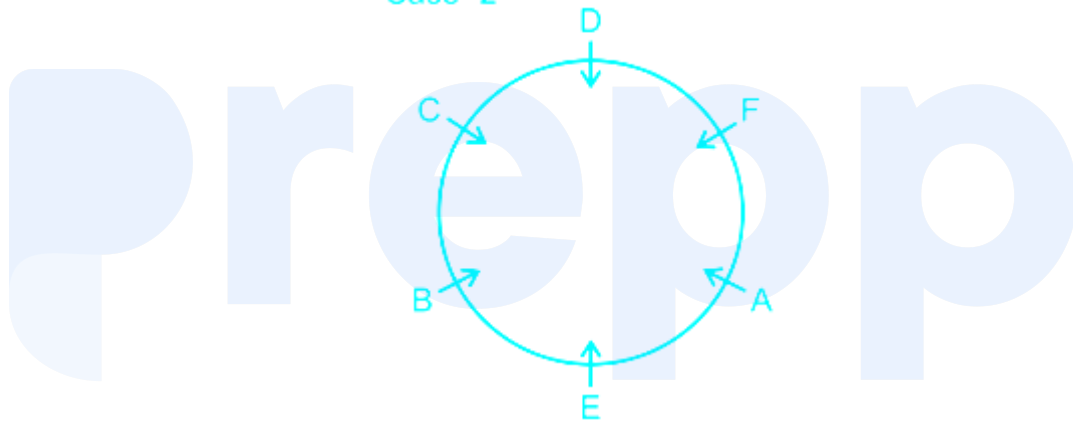

Now let's find out the person being kicked out in each round.

At the beginning of Round-1, B had the pillow. Speed of passing the pillow was 6 passes in 4 seconds and the song was being played for 28 s.

As there are 6 passes in 4 seconds, so there will be 42 passes in 28 seconds. So, starting from B in a clockwise direction, after 42 passes B will have the pillow. So, B will be kicked out in round 1.

Round	Person	Song duration
1	B	28
2		
3		
4		

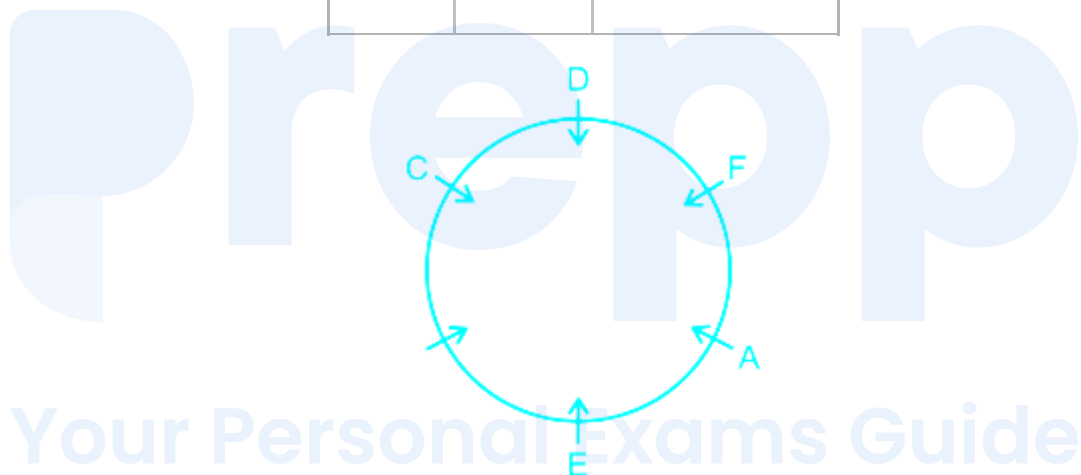

It is given that D was kicked out in the second round and speed of the pillow for this round was 7 passes in 4 seconds. In this round, the song was being played for more duration than that is being played in the first round.

As B was kicked out in the first round, so at the start of second round C has a pillow. So, the pillow is been passed from C in an anticlockwise direction.

The song is been played for more than 28 seconds but less than 60 seconds. So,

If the song was played for 32 seconds, E would have been kicked out.

If the song was played for 36 seconds, F would have been kicked out.

If the song was played for 40 seconds, C would have been kicked out.

If the song was played for 44 seconds, A would have been kicked out.

If the song was played for 48 seconds, D would have been kicked out.

So, we can say that the song was played for 48 seconds.

Round	Person	Song duration
1	B	28
2	D	48
3		
4		



Your Personal Exams Guide

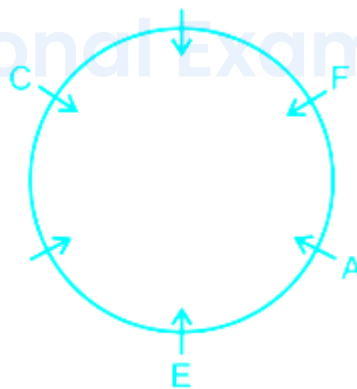

For Round-3, speed of the pillow was 9 passes in 5 seconds and the song was being played for 30 seconds.

As D was kicked out in the second round, so at the start of third round C has a pillow. So, the pillow is been passed from C in a clockwise direction.

As there are 9 passes in 5 seconds, so there will be 54 passes in 30 seconds. So, starting from C in a clockwise direction, after 54 passes A will have the pillow. So, A will be kicked out in round 3.

Round	Person	Song duration
1	B	28
2	D	48
3	A	30
4		

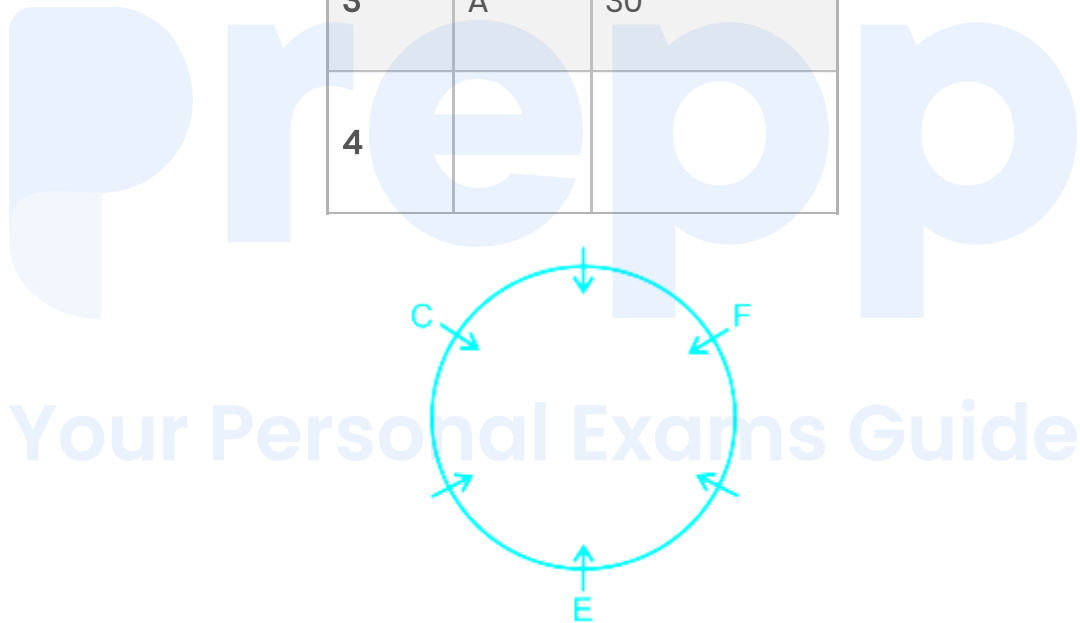

For Round-4, speed of the pillow was 7 passes in 3 seconds and the song was being played for 57 seconds.

A was kicked out in the third round, so at the start of fourth-round E has a pillow. So, the pillow is been passed from E in an anticlockwise direction.

As there are 7 passes in 3 seconds, so there will be 133 passes in 57 seconds. So, starting from E in an anticlockwise direction, after 133 passes F will have the pillow. So, F will be kicked out in round 4.

Round	Person	Song duration
1	B	28
2	D	48
3	A	30
4	F	57

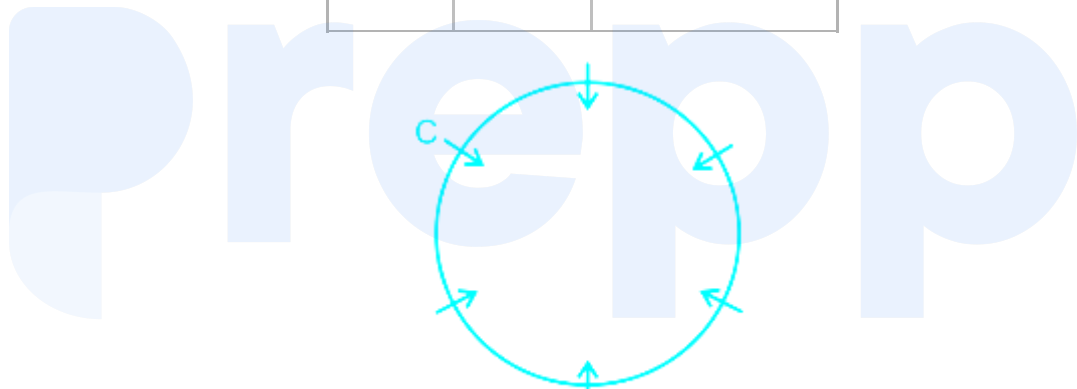

Your Personal Exams Guide

As a person kicked out in each round has to do some activity.let's find out the activity of each person.

The person who kicked out in a round in which the duration of the song is multiple of 3 hadn't danced.

Round	person	activity	Song duration
1	B	Dance	28
2	D		48
3	A		30
4	F		57

D had either danced or sung a song. So, D had sung a song.

Round	Person	activity	Song duration
1	B	Dance	28
2	D	sung a song	48
3	A		30
4	F		57

The persons who had sung a song wasn't kicked out in back to back rounds.

Round	Person	activity	Song duration
1	B	Dance	28
2	D	sung a song	48
3	A		30
4	F	Sung a song	57

Either person C or E had played Truth or dare. So, an only activity a remains is to do 50 push ups which are done by person A.

Round	Person	activity	Song duration
1	B	Dance	28
2	D	sung a song	48
3	A	50 push ups	30
4	F	Sung a song	57

Clearly, the length of the song played in the second round is 48 sec.

Hence, **48 sec** is the correct answer.

7. Answer: a

Explanation:

The seating arrangement of six peoples:

i) Two persons are sitting between D and E.

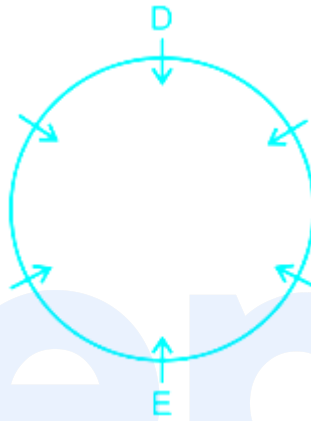

ii) A is not an immediate neighbour of D.

From the above statement, we have two cases i.e. Case-1 & Case-2;

Case- 1

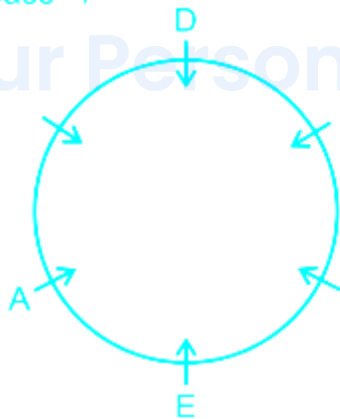

Case- 2

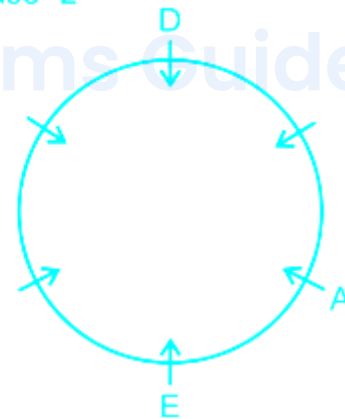

iii) One person is sitting between F and C. B is an immediate neighbour of C.

Case- 1

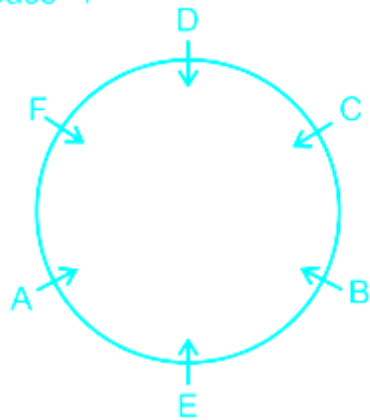

Case- 2

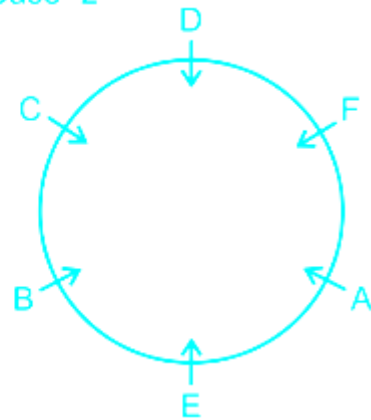

iv) B is not sitting at the immediate left of C. So, Case-1 gets eliminated.

Case- 2

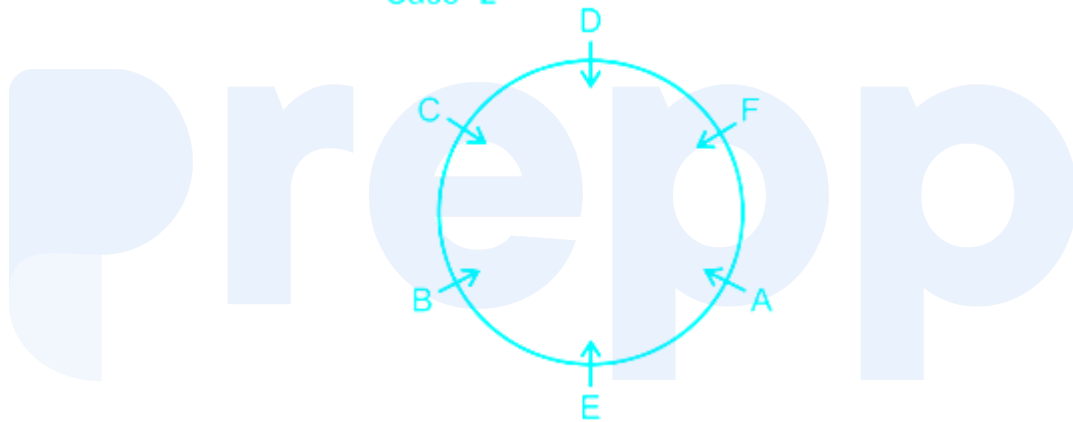

Now let's find out the person being kicked out in each round.

At the beginning of Round-1, B had the pillow. Speed of passing the pillow was 6 passes in 4 seconds and the song was being played for 28 s.

As there are 6 passes in 4 seconds, so there will be 42 passes in 28 seconds. So, starting from B in a clockwise direction, after 42 passes B will have the pillow. So, B will be kicked out in round 1.

Round	Person	Song duration
1	B	28
2		
3		
4		

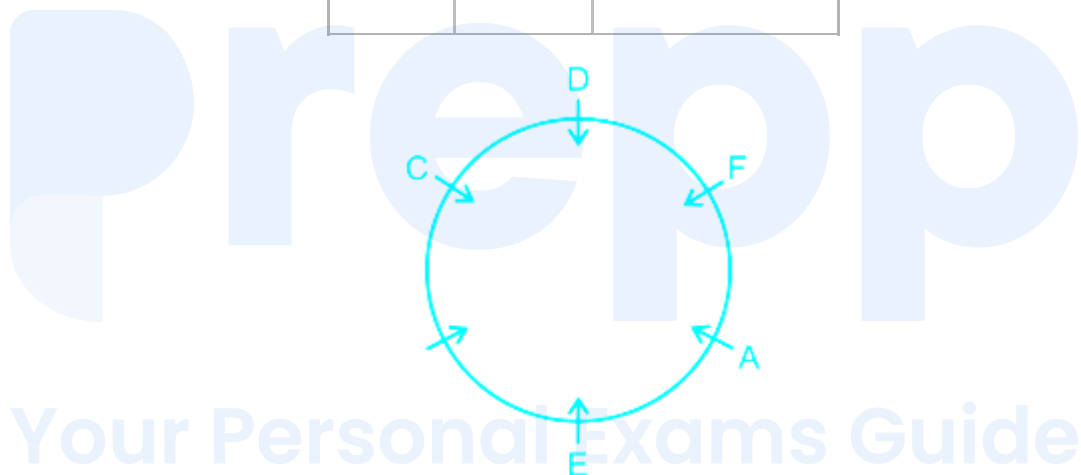

It is given that D was kicked out in the second round and speed of the pillow for this round was 7 passes in 4 seconds. In this round, the song was being played for more duration than that is being played in the first round.

As B was kicked out in the first round, so at the start of second round C has a pillow. So, the pillow is been passed from C in an anticlockwise direction.

The song is been played for more than 28 seconds but less than 60 seconds. So,

If the song was played for 32 seconds, E would have been kicked out.

If the song was played for 36 seconds, F would have been kicked out.

If the song was played for 40 seconds, C would have been kicked out.

If the song was played for 44 seconds, A would have been kicked out.

If the song was played for 48 seconds, D would have been kicked out.

So, we can say that the song was played for 48 seconds.

Round	Person	Song duration
1	B	28
2	D	48
3		
4		



Your Personal Exams Guide

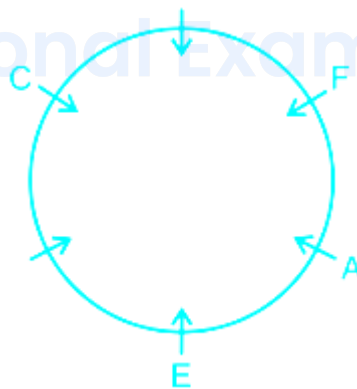

For Round-3, speed of the pillow was 9 passes in 5 seconds and the song was being played for 30 seconds.

As D was kicked out in the second round, so at the start of third round C has a pillow. So, the pillow is been passed from C in a clockwise direction.

As there are 9 passes in 5 seconds, so there will be 54 passes in 30 seconds. So, starting from C in a clockwise direction, after 54 passes A will have the pillow. So, A will be kicked out in round 3.

Round	Person	Song duration
1	B	28
2	D	48
3	A	30
4		

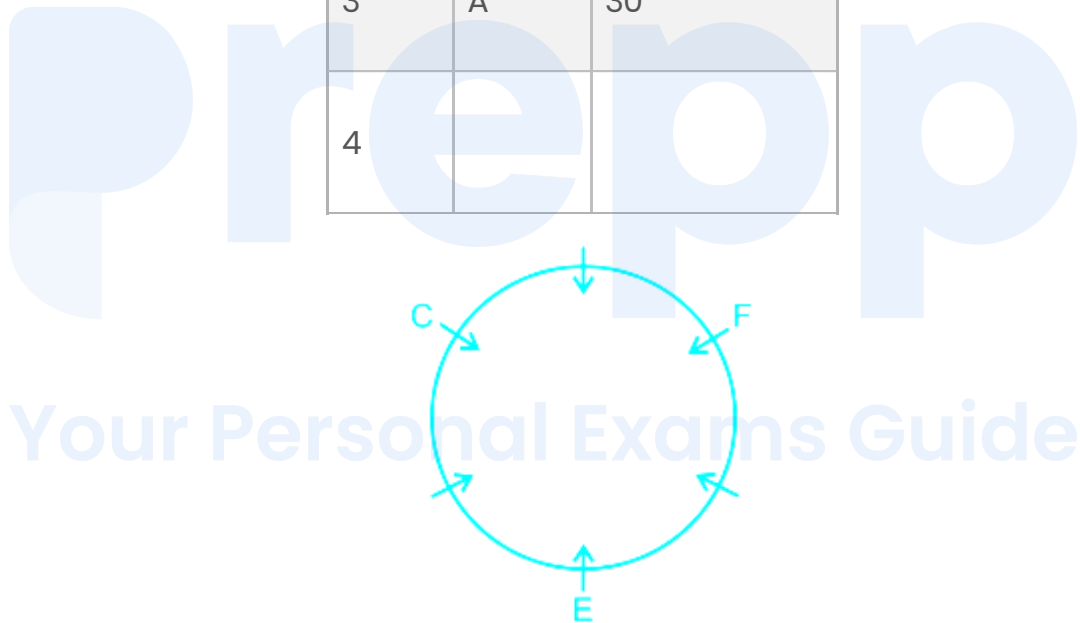

For Round-4, speed of the pillow was 7 passes in 3 seconds and the song was being played for 57 seconds.

A was kicked out in the third round, so at the start of fourth-round E has a pillow. So, the pillow is been passed from E in an anticlockwise direction.

As there are 7 passes in 3 seconds, so there will be 133 passes in 57 seconds. So, starting from E in an anticlockwise direction, after 133 passes F will have the pillow. So, F will be kicked out in round 4.

Round	Person	Song duration
1	B	28
2	D	48
3	A	30
4	F	57

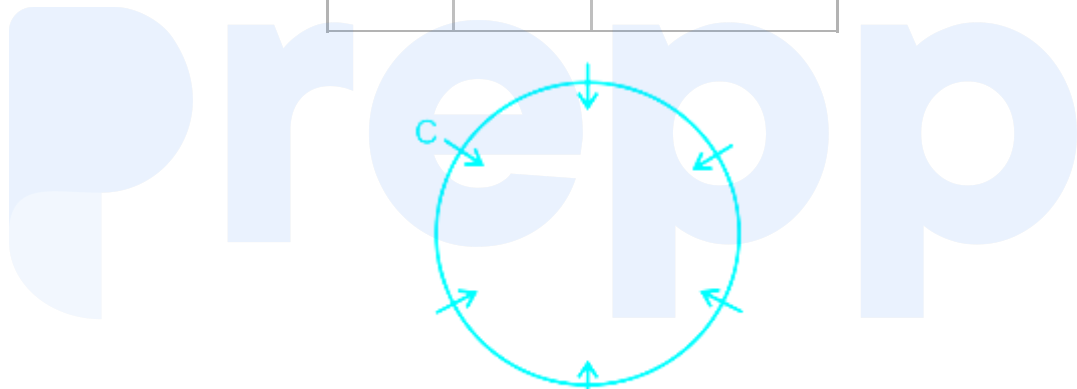

Your Personal Exams Guide

As a person kicked out in each round has to do some activity.let's find out the activity of each person.

The person who kicked out in a round in which the duration of the song is multiple of 3 hadn't danced.

Round	person	activity	Song duration
1	B	Dance	28
2	D		48
3	A		30
4	F		57

D had either danced or sung a song. So, D had sung a song.

Round	Person	activity	Song duration
1	B	Dance	28
2	D	sung a song	48
3	A		30
4	F		57

The persons who had sung a song wasn't kicked out in back to back rounds.

Round	Person	activity	Song duration
1	B	Dance	28
2	D	sung a song	48
3	A		30
4	F	Sung a song	57

Either person C or E had played Truth or dare. So, an only activity a remains is to do 50 push ups which are done by person A.

Round	Person	activity	Song duration
1	B	Dance	28
2	D	sung a song	48
3	A	50 push ups	30
4	F	Sung a song	57

Hence, **B** is the correct answer.

8. Answer: a

Explanation:

The seating arrangement of six peoples:

i) Two persons are sitting between D and E.

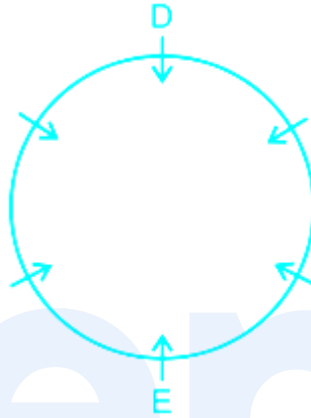

ii) A is not an immediate neighbour of D.

From the above statement, we have two cases i.e. Case-1 & Case-2;

Case-1

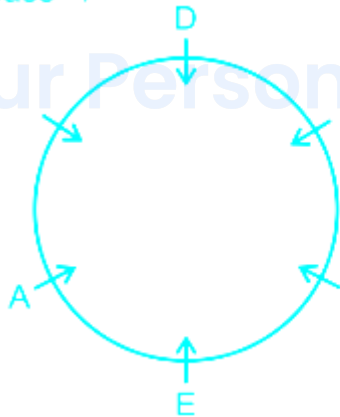

Case-2

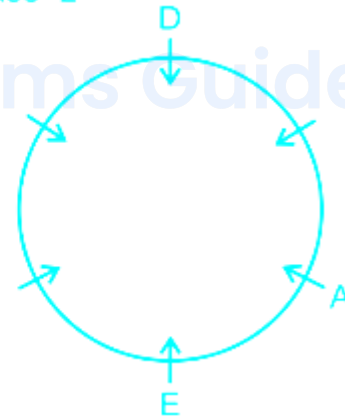

iii) One person is sitting between F and C. B is an immediate neighbour of C.

Case- 1

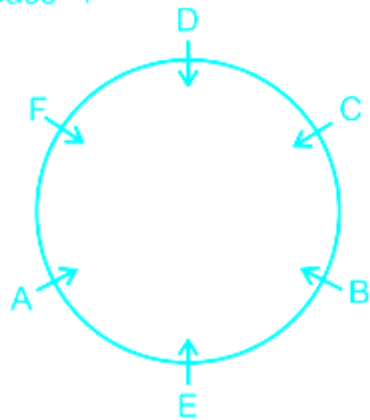

Case- 2

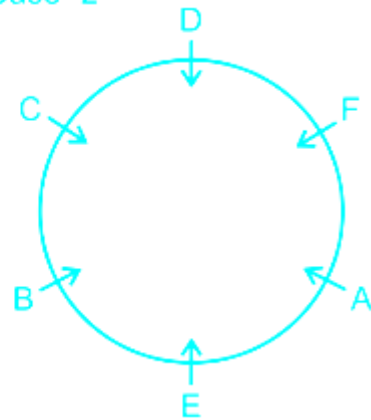

iv) B is not sitting at the immediate left of C. So, Case-1 gets eliminated.

Case- 2

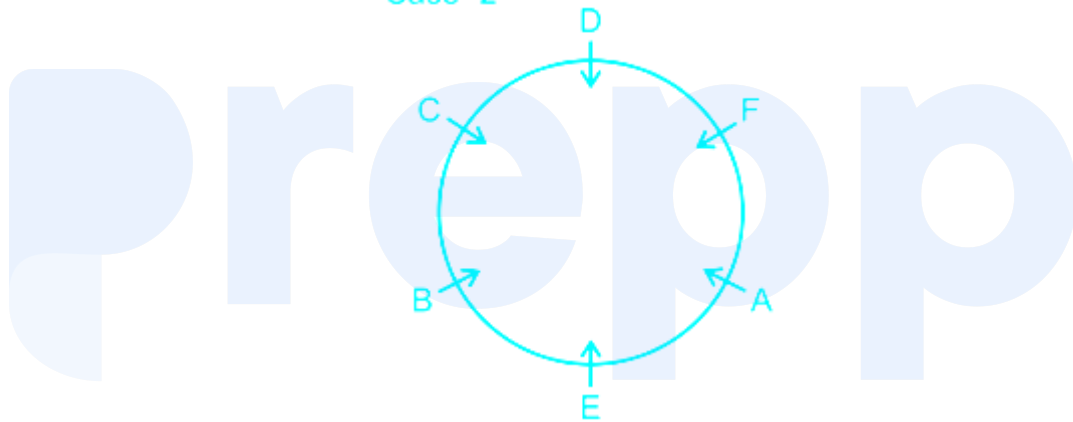

Now let's find out the person being kicked out in each round.

At the beginning of Round-1, B had the pillow. Speed of passing the pillow was 6 passes in 4 seconds and the song was being played for 28 s.

As there are 6 passes in 4 seconds, so there will be 42 passes in 28 seconds. So, starting from B in a clockwise direction, after 42 passes B will have the pillow. So, B will be kicked out in round 1.

Round	Person	Song duration
1	B	28
2		
3		
4		

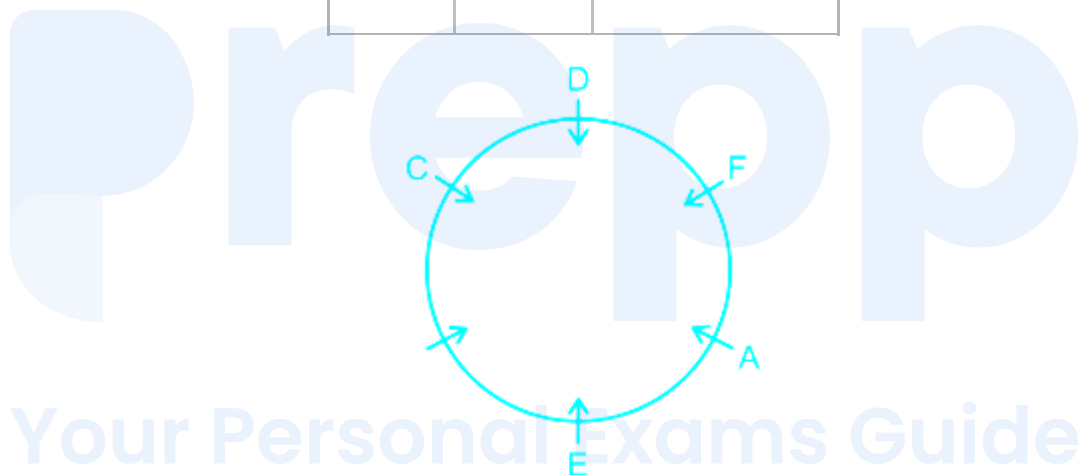

It is given that D was kicked out in the second round and speed of the pillow for this round was 7 passes in 4 seconds. In this round, the song was being played for more duration than that is being played in the first round.

As B was kicked out in the first round, so at the start of second round C has a pillow. So, the pillow is been passed from C in an anticlockwise direction.

The song is been played for more than 28 seconds but less than 60 seconds. So,

If the song was played for 32 seconds, E would have been kicked out.

If the song was played for 36 seconds, F would have been kicked out.

If the song was played for 40 seconds, C would have been kicked out.

If the song was played for 44 seconds, A would have been kicked out.

If the song was played for 48 seconds, D would have been kicked out.

So, we can say that the song was played for 48 seconds.

Round	Person	Song duration
1	B	28
2	D	48
3		
4		



Your Personal Exams Guide

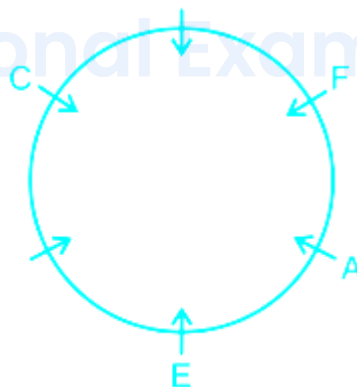

For Round-3, speed of the pillow was 9 passes in 5 seconds and the song was being played for 30 seconds.

As D was kicked out in the second round, so at the start of third round C has a pillow. So, the pillow is been passed from C in a clockwise direction.

As there are 9 passes in 5 seconds, so there will be 54 passes in 30 seconds. So, starting from C in a clockwise direction, after 54 passes A will have the pillow. So, A will be kicked out in round 3.

Round	Person	Song duration
1	B	28
2	D	48
3	A	30
4		

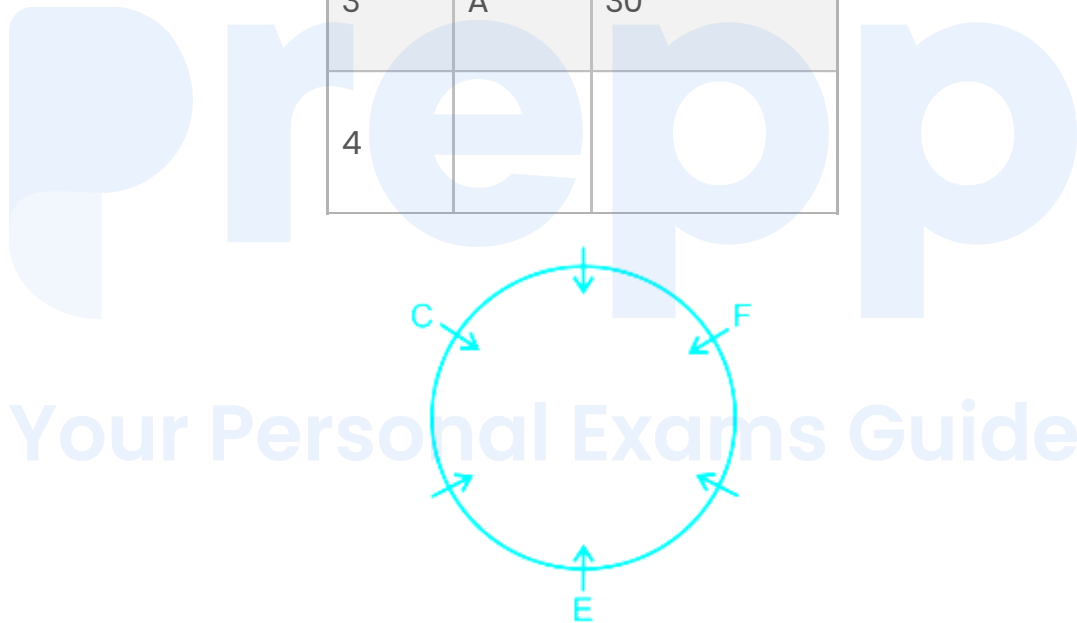

For Round-4, speed of the pillow was 7 passes in 3 seconds and the song was being played for 57 seconds.

A was kicked out in the third round, so at the start of fourth-round E has a pillow. So, the pillow is been passed from E in an anticlockwise direction.

As there are 7 passes in 3 seconds, so there will be 133 passes in 57 seconds. So, starting from E in an anticlockwise direction, after 133 passes F will have the pillow. So, F will be kicked out in round 4.

Round	Person	Song duration
1	B	28
2	D	48
3	A	30
4	F	57

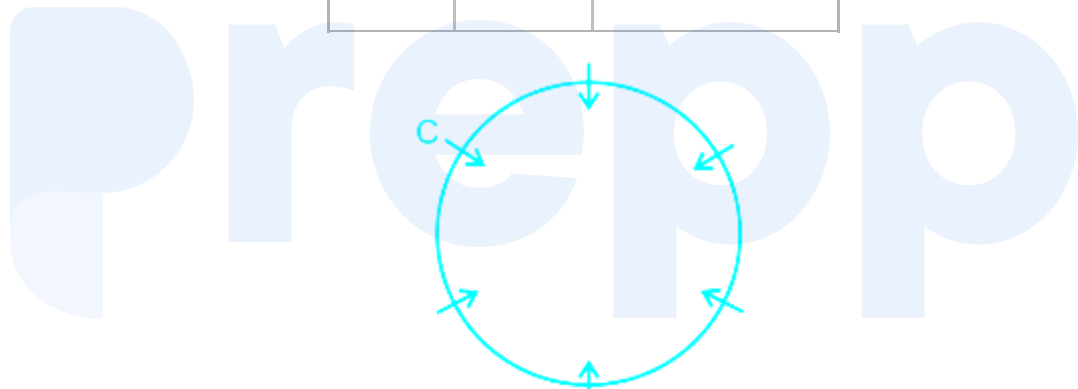

Your Personal Exams Guide

As a person kicked out in each round has to do some activity.let's find out the activity of each person.

The person who kicked out in a round in which the duration of the song is multiple of 3 hadn't danced.

Round	person	activity	Song duration
1	B	Dance	28
2	D		48
3	A		30
4	F		57

D had either danced or sung a song. So, D had sung a song.

Round	Person	activity	Song duration
1	B	Dance	28
2	D	sung a song	48
3	A		30
4	F		57

The persons who had sung a song wasn't kicked out in back to back rounds.

Round	Person	activity	Song duration
1	B	Dance	28
2	D	sung a song	48
3	A		30
4	F	Sung a song	57

Either person C or E had played Truth or dare. So, an only activity a remains is to do 50 push ups which are done by person A.

Round	Person	activity	Song duration
1	B	Dance	28
2	D	sung a song	48
3	A	50 push ups	30
4	F	Sung a song	57

Hence, **C or E** is the correct answer.

9. Answer: e

Explanation:

The seating arrangement of six peoples:

i) Two persons are sitting between D and E.

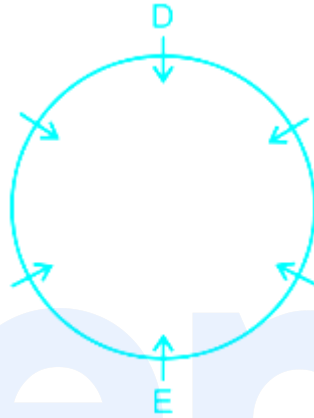

ii) A is not an immediate neighbour of D.

From the above statement, we have two cases i.e. Case-1 & Case-2;

Case- 1

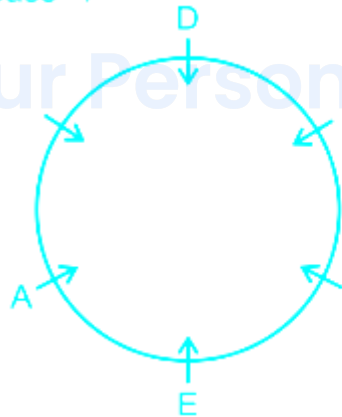

Case- 2

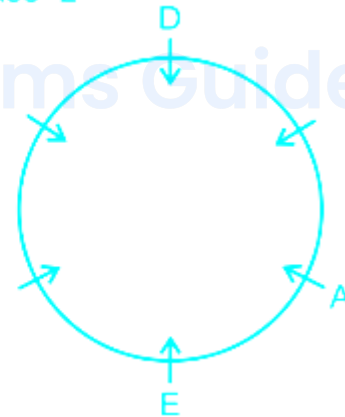

iii) One person is sitting between F and C. B is an immediate neighbour of C.

Case- 1

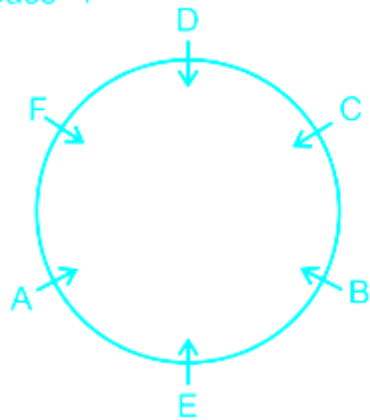

Case- 2

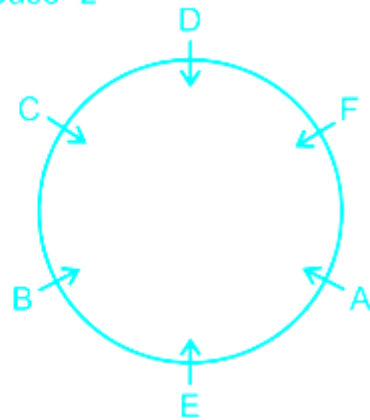

iv) B is not sitting at the immediate left of C. So, Case-1 gets eliminated.

Case- 2

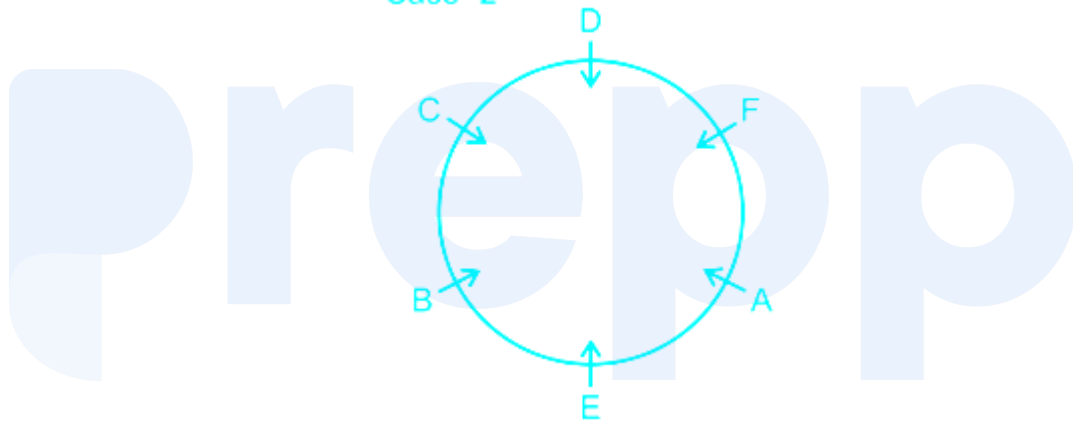

Now let's find out the person being kicked out in each round.

At the beginning of Round-1, B had the pillow. Speed of passing the pillow was 6 passes in 4 seconds and the song was being played for 28 s.

As there are 6 passes in 4 seconds, so there will be 42 passes in 28 seconds. So, starting from B in a clockwise direction, after 42 passes B will have the pillow. So, B will be kicked out in round 1.

Round	Person	Song duration
1	B	28
2		
3		
4		

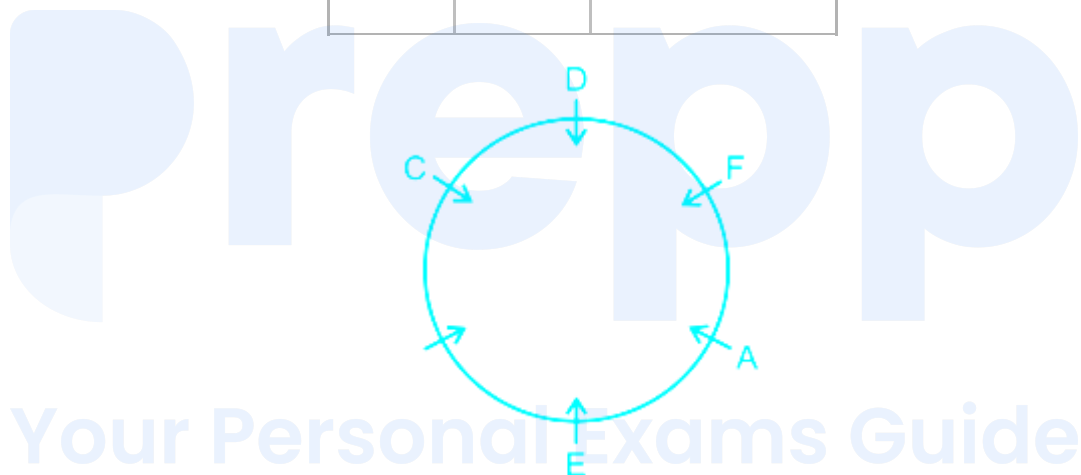

It is given that D was kicked out in the second round and speed of the pillow for this round was 7 passes in 4 seconds. In this round, the song was being played for more duration than that is being played in the first round.

As B was kicked out in the first round, so at the start of second round C has a pillow. So, the pillow is been passed from C in an anticlockwise direction.

The song is been played for more than 28 seconds but less than 60 seconds. So,

If the song was played for 32 seconds, E would have been kicked out.

If the song was played for 36 seconds, F would have been kicked out.

If the song was played for 40 seconds, C would have been kicked out.

If the song was played for 44 seconds, A would have been kicked out.

If the song was played for 48 seconds, D would have been kicked out.

So, we can say that the song was played for 48 seconds.

Round	Person	Song duration
1	B	28
2	D	48
3		
4		



Your Personal Exams Guide

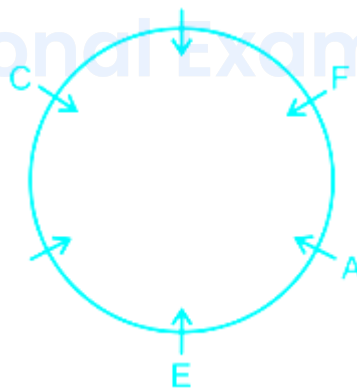

For Round-3, speed of the pillow was 9 passes in 5 seconds and the song was being played for 30 seconds.

As D was kicked out in the second round, so at the start of third round C has a pillow. So, the pillow is been passed from C in a clockwise direction.

As there are 9 passes in 5 seconds, so there will be 54 passes in 30 seconds. So, starting from C in a clockwise direction, after 54 passes A will have the pillow. So, A will be kicked out in round 3.

Round	Person	Song duration
1	B	28
2	D	48
3	A	30
4		

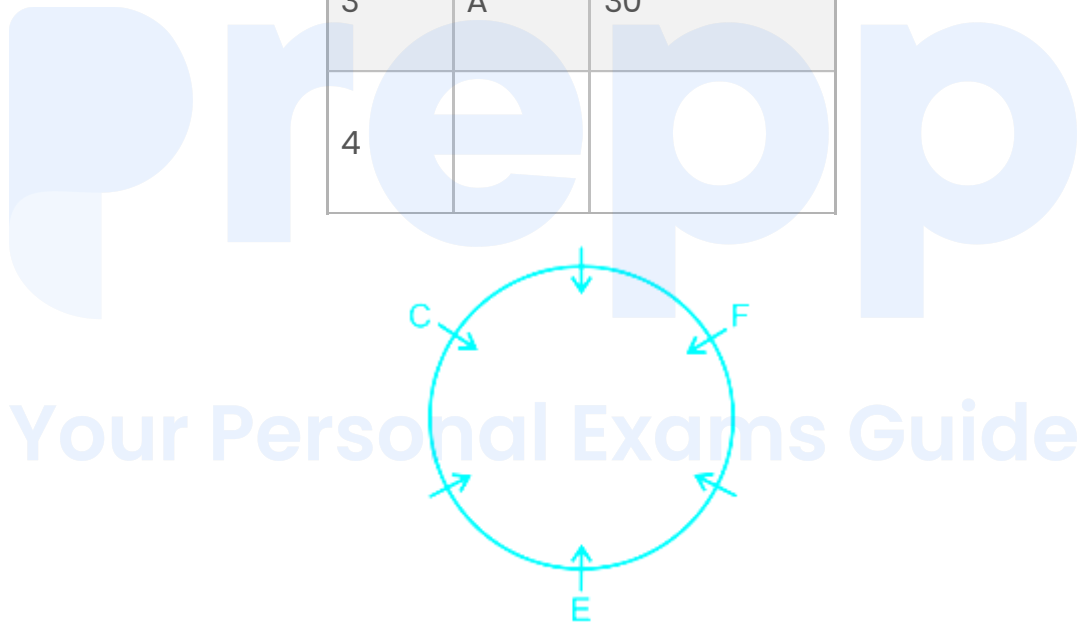

For Round-4, speed of the pillow was 7 passes in 3 seconds and the song was being played for 57 seconds.

A was kicked out in the third round, so at the start of fourth-round E has a pillow. So, the pillow is been passed from E in an anticlockwise direction.

As there are 7 passes in 3 seconds, so there will be 133 passes in 57 seconds. So, starting from E in an anticlockwise direction, after 133 passes F will have the pillow. So, F will be kicked out in round 4.

Round	Person	Song duration
1	B	28
2	D	48
3	A	30
4	F	57

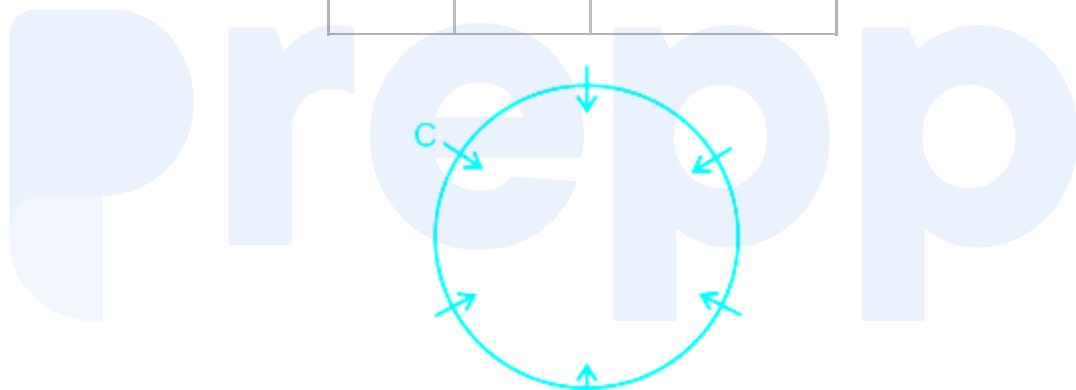

Your Personal Exams Guide

As a person kicked out in each round has to do some activity.let's find out the activity of each person.

The person who kicked out in a round in which the duration of the song is multiple of 3 hadn't danced.

Round	person	activity	Song duration
1	B	Dance	28
2	D		48
3	A		30
4	F		57

D had either danced or sung a song. So, D had sung a song.

Round	Person	activity	Song duration
1	B	Dance	28
2	D	sung a song	48
3	A		30
4	F		57

The persons who had sung a song wasn't kicked out in back to back rounds.

Round	Person	activity	Song duration
1	B	Dance	28
2	D	sung a song	48
3	A		30
4	F	Sung a song	57

Either person C or E had played Truth or dare. So, an only activity a remains is to do 50 push ups which are done by person A.

Round	Person	activity	Song duration
1	B	Dance	28
2	D	sung a song	48
3	A	50 push ups	30
4	F	Sung a song	57

F has performed **Singing a song** activity.

Hence, **Singing a song** is the correct answer.

10. Answer: b

Explanation:

The seating arrangement of six peoples:

i) Two persons are sitting between D and E.

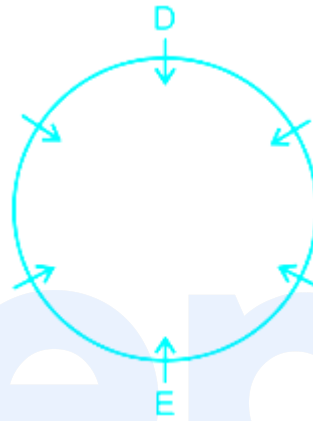

ii) A is not an immediate neighbour of D.

From the above statement, we have two cases i.e. Case-1 & Case-2;

Case- 1

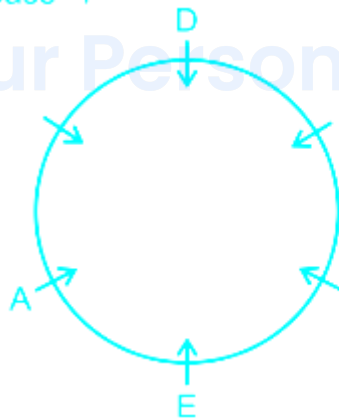

Case- 2

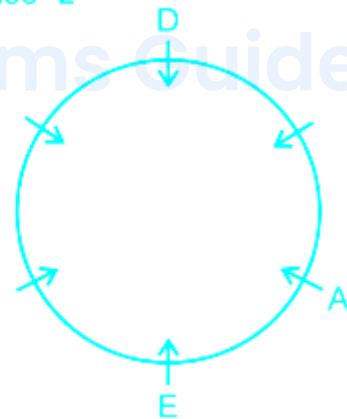

iii) One person is sitting between F and C. B is an immediate neighbour of C.

Case- 1

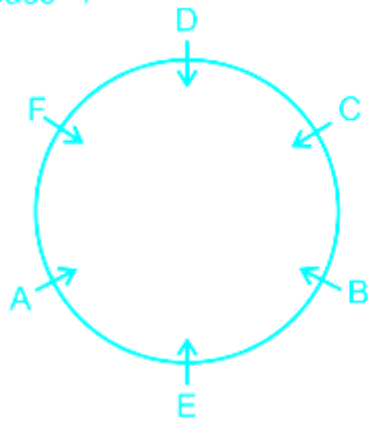

Case- 2

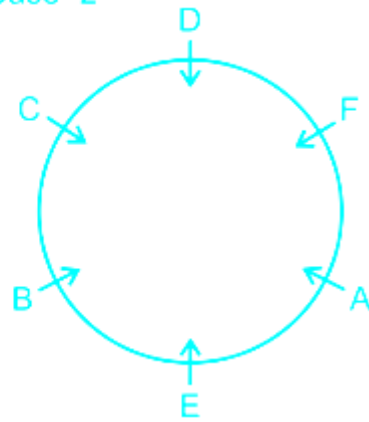

iv) B is not sitting at the immediate left of C. So, Case-1 gets eliminated.

Case- 2

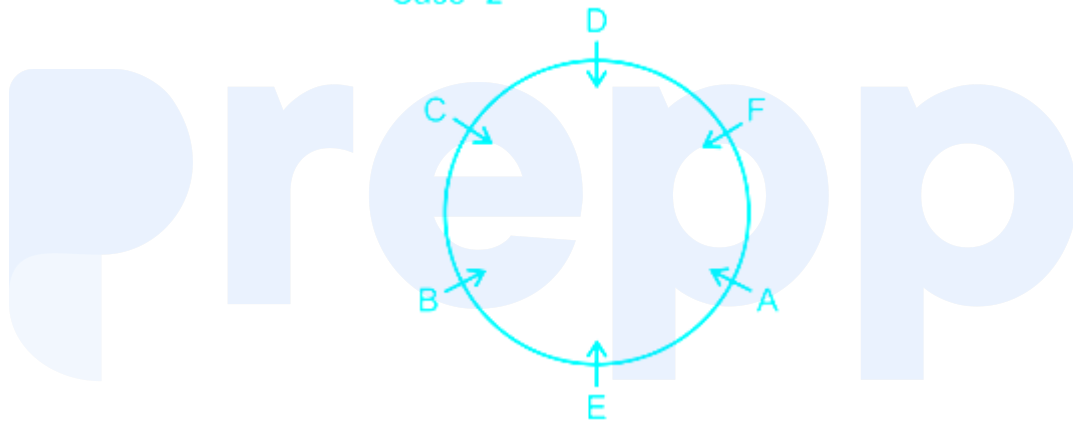

Now let's find out the person being kicked out in each round.

At the beginning of Round-1, B had the pillow. Speed of passing the pillow was 6 passes in 4 seconds and the song was being played for 28 s.

As there are 6 passes in 4 seconds, so there will be 42 passes in 28 seconds. So, starting from B in a clockwise direction, after 42 passes B will have the pillow. So, B will be kicked out in round 1.

Round	Person	Song duration
1	B	28
2		
3		
4		

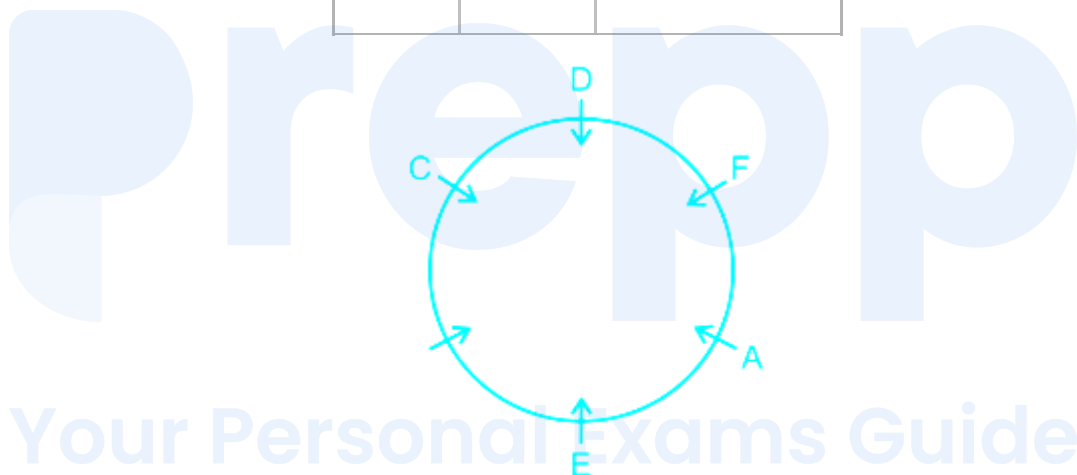

It is given that D was kicked out in the second round and speed of the pillow for this round was 7 passes in 4 seconds. In this round, the song was being played for more duration than that is being played in the first round.

As B was kicked out in the first round, so at the start of second round C has a pillow. So, the pillow is been passed from C in an anticlockwise direction.

The song is been played for more than 28 seconds but less than 60 seconds. So,

If the song was played for 32 seconds, E would have been kicked out.

If the song was played for 36 seconds, F would have been kicked out.

If the song was played for 40 seconds, C would have been kicked out.

If the song was played for 44 seconds, A would have been kicked out.

If the song was played for 48 seconds, D would have been kicked out.

So, we can say that the song was played for 48 seconds.

Round	Person	Song duration
1	B	28
2	D	48
3		
4		



Your Personal Exams Guide

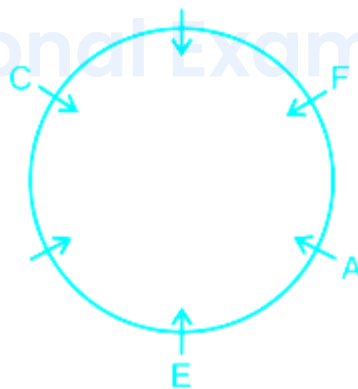

For Round-3, speed of the pillow was 9 passes in 5 seconds and the song was being played for 30 seconds.

As D was kicked out in the second round, so at the start of third round C has a pillow. So, the pillow is been passed from C in a clockwise direction.

As there are 9 passes in 5 seconds, so there will be 54 passes in 30 seconds. So, starting from C in a clockwise direction, after 54 passes A will have the pillow. So, A will be kicked out in round 3.

Round	Person	Song duration
1	B	28
2	D	48
3	A	30
4		

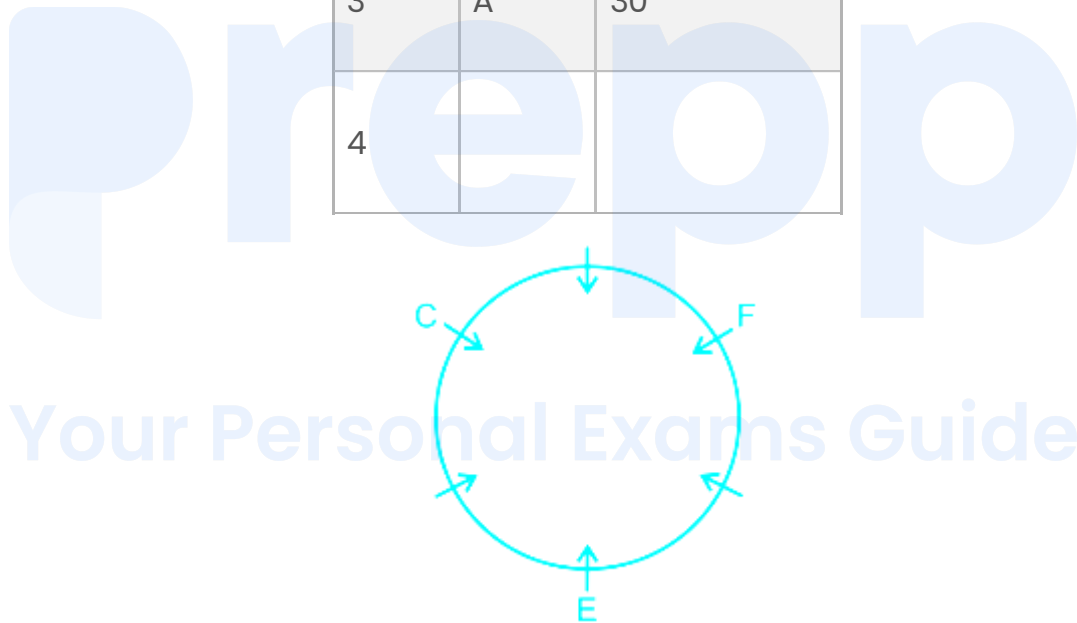

For Round-4, speed of the pillow was 7 passes in 3 seconds and the song was being played for 57 seconds.

A was kicked out in the third round, so at the start of fourth-round E has a pillow. So, the pillow is been passed from E in an anticlockwise direction.

As there are 7 passes in 3 seconds, so there will be 133 passes in 57 seconds. So, starting from E in an anticlockwise direction, after 133 passes F will have the pillow. So, F will be kicked out in round 4.

Round	Person	Song duration
1	B	28
2	D	48
3	A	30
4	F	57

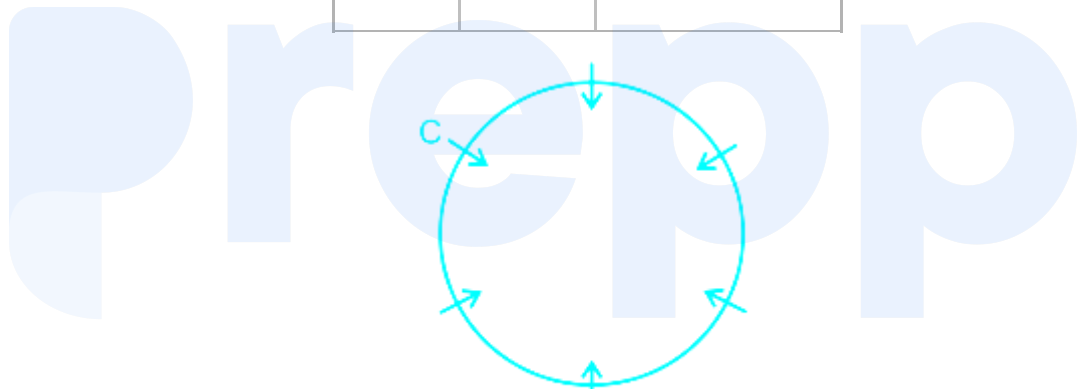

Your Personal Exams Guide

As a person kicked out in each round has to do some activity.let's find out the activity of each person.

The person who kicked out in a round in which the duration of the song is multiple of 3 hadn't danced.

Round	person	activity	Song duration
1	B	Dance	28
2	D		48
3	A		30
4	F		57

D had either danced or sung a song. So, D had sung a song.

Round	Person	activity	Song duration
1	B	Dance	28
2	D	sung a song	48
3	A		30
4	F		57

The persons who had sung a song wasn't kicked out in back to back rounds.

Round	Person	activity	Song duration
1	B	Dance	28
2	D	sung a song	48
3	A		30
4	F	Sung a song	57

Either person C or E had played Truth or dare. So, an only activity a remains is to do 50 push ups which are done by person A.

Round	Person	activity	Song duration
1	B	Dance	28
2	D	sung a song	48
3	A	50 push ups	30
4	F	Sung a song	57

A was kicked out during **Round-3**.

Hence, **Round-3** is the correct answer.